



REF: AMS11-120-T, AMS11-120-W-T

## Table Top Steam Sterilizer

### Models T-Edge 11

Cat. No. MAN205-0502003EN Rev. C

📄 Tuttnauer U.S.A. Co, Ltd., 25 Power Drive Hauppauge, NY, 11788, U.S.A.  
☎ Tel: (631) 737-4850, (800) 624-5836, 📠 Fax: (631) 737-0720

🏭 Tuttnauer. Ltd., Har Tuv Industrial Zone, B P.O. Box 170, Beit Shemesh, 9910101, Israel. ☎ Tel: 972 2 9904611, 📠 Fax: 972 2 9904730



# Operation and Maintenance Manual

## Table Top Steam Sterilizer

### Models T-Edge 11



REF: AMS11-120-T, AMS11-120-W-T



## Table of Contents

Paragraph	Page No.
1. GENERAL INFORMATION .....	1
1.1 Manufacturer and US Official Correspondence Information .....	1
1.2 Applicable Regulation and Quality Standards .....	2
1.3 Legend for Symbols appearing on the Labels and in this Manual .....	4
1.4 General Description of the Device .....	6
1.5 Intended Use .....	7
1.6 Intended Users .....	7
1.7 Warranty Description .....	7
1.8 Warranty Statement .....	7
1.9 Customer Inspection Upon Receipt of the Device .....	8
1.10 Device Specifications .....	9
1.11 Device Environmental Information .....	13
1.12 Requirements with concern to Water Quality .....	13
2. SAFETY .....	15
2.1 Safety Notes .....	16
2.2 Safety features incorporated in the device .....	17
3. CONTENT OF THE DEVICE PACKAGE .....	18
4. DEPICTION OF SYSTEM PARTS .....	19
4.1 Front View .....	19
4.2 Rear View .....	20
5. INSTALLATION INSTRUCTIONS .....	21
5.1 Lifting and Carrying .....	21
5.2 Device Placement and Operating Conditions .....	21
5.3 Connections to Utility Supplies .....	22
5.4 Storage .....	22
5.5 Initial Operation of the Device .....	23
5.6 Before starting the Autoclave .....	25
6. PRE-STERILIZATION CLEANING AND DISINFECTION OF INSTRUMENTS AND THEIR LOADING INTO THE DEVICE .....	28
7. OPERATING INSTRUCTIONS .....	32

---

7.1	Turning on the Device .....	32
7.2	Filling Water .....	32
7.3	Filling water in the reservoir .....	34
7.4	See the requirements concerning Water Quality, in Section 1.12 .....	35
7.5	Setting Date and Time .....	36
7.6	Class S and Class B .....	37
7.7	Setting Class S and Class B .....	39
8.	CONTROL PANEL .....	43
8.1	Home screen Description and Functions .....	44
8.2	Opening the Device Door .....	46
8.3	Starting a Cycle .....	47
8.4	Virus Protect program .....	50
8.5	Available Sterilization Programs and Test Programs .....	52
8.6	Cycle Succeeded / Cycle Failed Notifications and Follow-on .....	55
8.7	Aborting a cycle .....	56
8.8	Custom Programs .....	58
8.9	Cycles history .....	59
8.10	Opening the door and Unloading .....	61
8.11	Checking Waste Water Level .....	62
8.12	Draining the Reservoirs .....	62
9.	PREVENTIVE AND SCHEDULED MAINTENANCE TO BE PERFORMED BY THE OPERATOR .....	64
9.1	Daily Maintenance .....	64
9.2	Weekly Maintenance .....	64
9.3	Monthly Maintenance .....	65
9.4	Periodic Maintenance .....	65
10.	FULL LIST OF INFORMATIVE SCREEN DISPLAY SYMBOLS, OPERATING MESSAGES, ERROR MESSAGES AND TROUBLESHOOTING .....	70
10.1	Symbols .....	70
10.2	Error messages & Troubleshooting .....	72
11.	TSC PRINTER INSTALLATION (OPTIONAL) .....	77
11.1	General printer information .....	77
11.2	Important safety instructions .....	80
11.3	Installation for the first time .....	81
11.4	Open the printer top cover .....	82

---

11.5 Loading thermal printer paper roll/ Label roll .....	82
11.6 Connecting the interface cables to the printer .....	85
11.7 Connecting power and interface cables .....	86
11.8 Starting the printer .....	86
11.9 Setting Printer definitions .....	87
12. CHAMBER CLEAN PROGRAM .....	90
12.1 General .....	90
General .....	90
12.2 Chamber Clean cleaning procedure .....	91
13. FACTORY CODES FOR END USER .....	96

# 1. General Information

---

## 1.1 Manufacturer and US Official Correspondence Information



T-Edge 11 Autoclave is manufactured by Tuttnauer Ltd., Located Har – Tuv B Industrial Zone, P.O. Box 170, Beit Shemesh 9910101, Israel.

☎ Tel: +972-2-9904611

The US Official Correspondence is:

🇺🇸 Tuttnauer U.S.A. Co, Ltd. 25 Power Drive Hauppauge, NY, 11788, USA.

☎ Tel: (631) 737 4850, (800) 624 5836, 📠 Fax: (631) 737 0720



## 1.2 Applicable Regulation and Quality Standards

The life cycle of Tuttnauer's T- Edge 11 is in compliance with the following regulation and quality standards:

### Medical Device Directive 93/42/EEC as amended by 2007/47/EC

**Medical Device Single Audit Program**      companion document, doc# MDSAP AU G0002.1.004 rev. 13-04-2017Ft

**MDSAP audit approach**      doc# MDSAP AU P0002.005

### FDA QSR 21 CFR part 820 & part 11

**Australian Therapeutic Goods**      (Medical Devices) Regulations 2002

**Brazilian Good Manufacturing Practices**      (RDC ANVISA 16/2013, 67/2009, 56/2001, 23/2012)

**Japanese QMS Ordinance**      (MHLW MO 169)

**Canadian MDR (CMDR)**      SOR/98-282 (2018), consolidated

**Global Unique Device Identification Database (GUDID)**      Guidance for Industry and Food and Drug Administration Staff

**ISO 9001:**      Quality Management System

**EN ISO 13485:**      Quality Management System – Medical Devices

**ISO 14001:**      Environmental management system









**ISO 17025:**      General requirements for the competence of testing and calibration laboratories







**EN ISO 14971:**      Medical devices – Application of risk management for medical devices

<b>ASME Code</b>	Section I and Section VIII. Div. I
<b>PED</b>	2014/68/EU
<b>Chinese Regulations</b>	Special Equipment Licensing Office
<b>EN 13060:</b>	Small Steam Sterilizer
<b>ANSI/AAMI/ST55:</b>	Tabletop Steam Sterilizer
<b>ISO 17665:</b>	Sterilization of health care products – Moist heat
<b>ANSI/AAMI/ST79:</b>	Comprehensive guide to steam sterilization and sterility assurance in health care facilities
<b>IEC 61010-1 / UL 61010-1:</b>	Safety requirements for electrical equipment for measurement, control, and laboratory use – Part 1: General requirements
<b>IEC 61010-2-040:</b>	Safety requirements for electrical equipment for measurement, control, and laboratory use – Part 2-040: Requirements for sterilizers and washer-disinfectors used to treat medical materials
<b>EN 613261-1:</b>	EMC Requirements for Electrical Equipment
<b>IEC 62304:</b>	Medical Device Software – Software life cycle processes

### 1.3 Legend for Symbols appearing on the Labels and in this Manual

Table 1 - Device labeling

	Manufacturer
	Year of Manufacturing
	Catalog Number
	Serial Number
	Consult the Operation and Maintenance Manual (User Manual) before use
<p><b>IP31</b></p>	Ingress Protection
	Keep away from sunlight and protect from heat.
	For Indoor Use Only
	Keep dry

	<p>Disposal according to electronic scrap ordinance</p>
	<p>This side up (during transport and shipment)</p>
	<p>Fragile (during transport and shipment)</p>
 OR 	<p>A warning or precaution as detailed in the Operation and Maintenance Manual (User Manual)</p>
 OR 	<p>Caution! Hot Surface</p>

## **1.4 General Description of the Device**

The autoclave is fully automatic (a computerized control unit ensures a fully automatic sterilization cycle, control and monitoring of physical parameters and a clear documentation of the sterilization cycle. Drying is performed with the door closed)

This autoclave uses steam as a sterilizing agent.

The steam is produced by warming up a controlled amount of water inserted to a pipe heating element, and then to the chamber. This technique saves energy and water consumption.

The autoclave is equipped with a Pipe heating element and with chamber heaters to maintain the steam inside the chamber.

The autoclave is equipped with a vacuum system, which supports and improves:

- Removal of residual air from packs and porous load and most kinds of tubes (rubber, plastic etc.) by vacuum at the first stage of the cycle.
- Steam penetration into the load; resulting in effective sterilization.
- Temperature uniformity.
- Post sterilization drying phase

A touchscreen is used for monitoring and control purposes.

The device has a built -in USB port to enable the operation of an external optional barcode printer:

- The barcode printer can print labels with a unique cycle ID barcode, operator name, sterilization and expiry dates
- One barcode printer can be connected to the machine.
- The printer connection to the machine, by using a USB socket, with a dedicated cable.
- Barcode printer power supply voltage can range between 100-240V.
- A barcode printer is an optional addition to the autoclave

The device features built-in memory to record up to 999 sterilization cycles. These can be exported to a USB device to be transferred to a PC.

The device has a built-in Network Port for use with optional Tuttnauer's R.PC.R software when connected to your local network.

The autoclave has two optional configurations (available upon request):

- **Basic:** Demineralized water is supplied by a manually filled reservoir, demineralized water overflow outlet on the rear cover:  
(device catalog number: AMS11-120-T - **T-Edge 11**)
- **Automatic:** Demineralized water direct inlet from the water supply system, demineralized water overflow, and waste water outlet on the rear cover:  
(device catalog number: AMS11-120-W-T - **T-Edge 11-W**)

## **1.5 Intended Use**

The T-Edge 11 tabletop autoclave is designed for sterilization of medical and surgical goods such as wrapped and unwrapped solid, hollow, and porous loads used in dental and medical clinics, first aid rooms, hospitals, and laboratories etc.

## **1.6 Intended Users**

The T-Edge 11 tabletop autoclave is intended for use by hospital personnel and other medical personnel as well as laboratory personnel.

All autoclave users must receive training in proper usage from an experienced employee. Every new employee must undergo a training period under an experienced employee.

## **1.7 Warranty Description**

**This warranty does not include routine cleaning and preventive maintenance, to be performed according to instructions in chapter 8.**

Tuttnauer warranties all new autoclaves to be free from defects in material and workmanship for a period of two (2) years, covering the parts (except door gaskets and air filters – they are considered wear items).

Tuttnauer warranties all chambers for a period of ten (10) years against defects in materials and workmanship.

This warranty does not apply to any product that has been subjected to misuse, neglect, accident or improper installation or application, nor shall it extend to autoclaves that have been repaired or altered outside the factory without prior authorization from Tuttnauer.

Tuttnauer's obligation is limited to the repair or replacement of parts for the autoclave. This warranty will be void if the unit is not purchased from an authorized Tuttnauer dealer. No other warranties or obligations are expressed or implied.

## **1.8 Warranty Statement**

The warranty registration must be completed and returned to our service departments; within fourteen (14) days of purchase or the warranty will be void.

Our American Representative's Technical Service Department can be reached at:

✉ Tuttnauer U.S.A. Co, Ltd. 25 Power Drive Hauppauge, NY, 11788, USA.  
☎ Tel (631) 737 4850, (800) 624 5836, 📠 Fax: (631) 737 0720

**Note:** If there is any difficulty with this autoclave, and the solution is not covered in this manual, contact our representative or us first. Do not attempt to service this autoclave yourself. Describe the difficulty as clearly as possible so we may be able to diagnose the problem and provide a prompt solution.

If replacement parts are needed, stipulate the model and serial number of the machine.

No autoclaves will be accepted for repair without proper authorization from us. All transportation charges must be paid both ways by the owner.

**For technical information or service please contact us at:**

✉ Tuttnauer U.S.A. Co, Ltd. 25 Power Drive Hauppauge, NY, 11788, USA.  
☎ Tel: (631) 737 4850, (800) 624 5836, 📠 Fax: (631) 737 0720

Tuttnauer Ltd., Har – Tuv B Industrial Zone, P.O. Box 170, Beit Shemesh 9910101, Israel ☎ Tel: +972-2-9904611

## **1.9 Customer Inspection Upon Receival of the Device**

Upon receiving your Tuttnauer Autoclave, carefully inspect the outside of the shipping carton for signs of damage. If any damage to the carton is found, note the location with respect to the autoclave and check that area of the autoclave carefully once it is fully unpacked. Observe packing method and retain packing materials until the unit has been inspected. Mechanical inspection involves checking for signs of physical damage such as: scratched panel surfaces, broken knobs, damaged gasket etc.

**If any damage is found, contact your dealer as soon as possible so that they can file a claim with the shipping carrier and also notify Tuttnauer.**

All Tuttnauer products are carefully inspected prior to shipment and all reasonable precautions are taken in preparing them for shipment to assure safe arrival at their destination.

## 1.10 Device Specifications

### 1.10.1 Overall Dimensions:

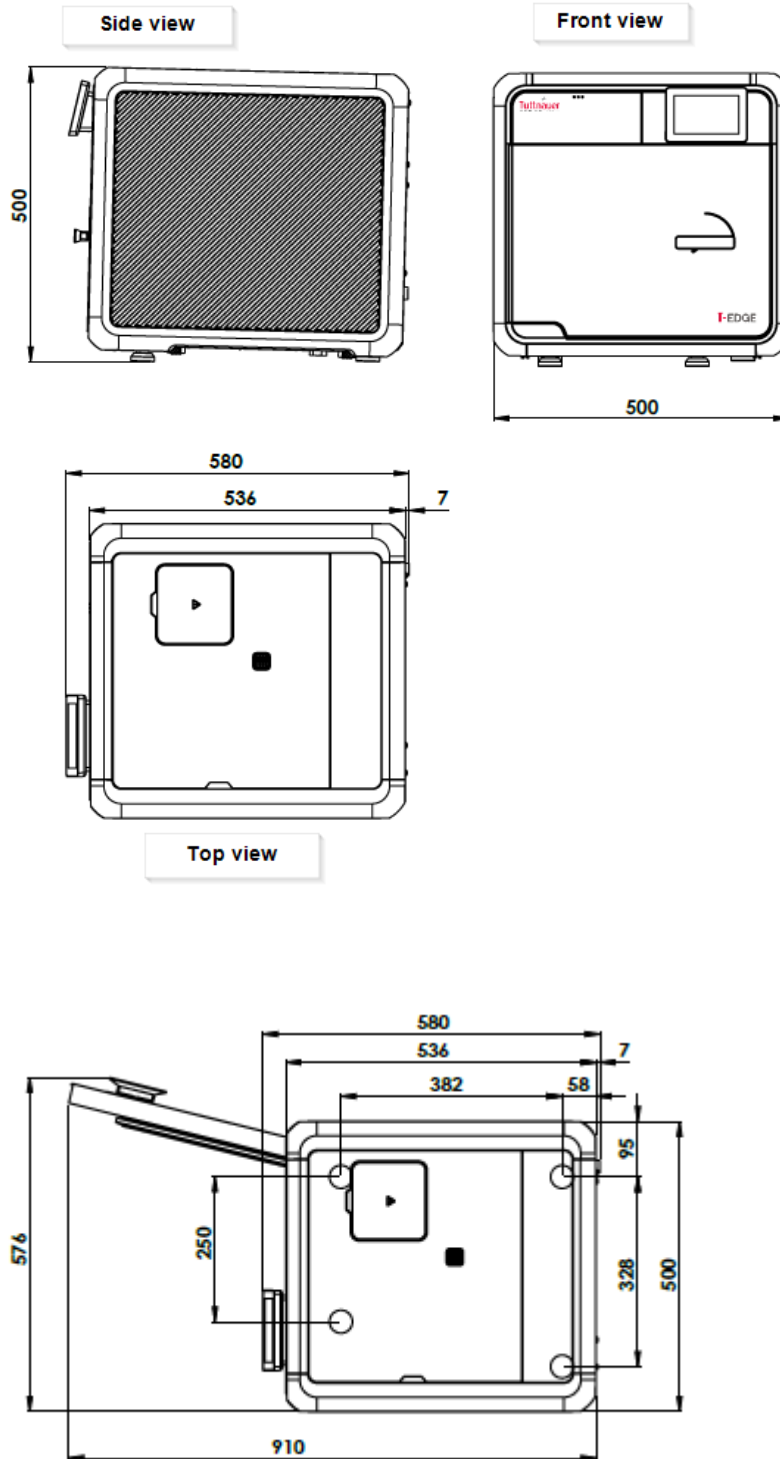



### 1.10.2 T-Edge11 fit into sterilization center cabinet - recommended dimensions:

To allow adequate cooling & ventilation of the autoclave placed inside the sterilization center cabinet, the following T-Edge11 cabinet sizes are recommended:

Width - 23.65" - 24.40"/60-62cm; Height – 22.25" - 22.65"/56.5-57.5cm; Min. Depth - 24.9"-25.2"/63.2-64cm

**Note:** The imperial dimensions in inches/lbs are approximated to less than 3 percent.

### 1.10.3 Device Properties

*Table 2 - Properties of the device*

Property		Dimension
External size	Width	~19.7"(50cm)
	Height	~19.7"(50cm)
	Depth	~22.8" (58 cm) supporting common install base carry a ~23" (60 cm) counter top
Chamber	Diameter	~11"(28 cm)
	Depth	~18"(46 cm)
	Volume	~913 Ounces (27.2lit)
	Usable chamber space	75% ( ~685 Ounces / ~20.5 L)
Max. Allowable Working Pressure (MAWP)		~40.6PSI (2.8 bar)
Maximum load per item		~0.45 lbs. (0.2kg)
Maximum load per tray	Unwrapped	~4 lbs. (1.8kg)
	Wrapped	~2.4 lbs (1.08kg)
Maximum Solid load	Unwrapped	~19.8 lbs (9kg)
	Wrapped	~11.9 lbs (5.4kg)
Maximum textile load		~4.4 lbs (2kg)

Property		Dimension
Tray dimensions		~16.6" x~8.1"x~0.8" (42.1cm x 20.7cm x2.05cm)
No. of trays		5
Net weight		~124lbs (56kg)
Shipping weight		~152lbs (69kg)
Floor loading requirements		~165 lbs(75kg).
Mineral-free water reservoir	Max. water volume	Overflow (up to the float) – ~155 Ounces (4.6lit)
	Min. water volume	~33.8 Ounces (1lit)
	The volume used by the sterilization cycle/load having the highest steam consumption	Recorded ~30 Ounces (~900ml) for "Wrapped 273F" + Virus Protect
Used (waste) water reservoir	Max. water volume	Max vol. –./~135 Ounces /(4.0 lit) Float – ~125 Ounces (3.7lit.) max allowed for start cycle
Safety relief valve		~40 PSI (2.8 bar)
Load No. counter		Counting from 0 to 999 and nullifies.

#### 1.10.4 Device Electrical Data

Table 3 - Electrical data

Property	Value
Total Power	1500W
Voltage	1Ph / 120 VAC
Amperage	12.5A
Protection against electrical shock	IEC 61010-1
Mains supply fluctuation	+/- 10%
Frequency (Hz)	60Hz

#### 1.10.5 Utility Requirements

Table 4 - Requirements pertaining the utilities

Property	Value
Mineral-free water	See table in Water Quality
Mineral-free water inlet	Optional - 1/2" automatic
Drain	Optional - 3/4", withstanding temp. of 80°C
Power supply	* 1 phase /120VAC ±10%, 60Hz, 15A.
Recommended circuit breaker	15A

\* According to the local network.



**Caution!**

In order to avoid any injury by electrical hazard, it is recommended that a ground fault protection device (GFCI) be installed in the electrical panel feeding the autoclave (local codes may make this mandatory).

The electrical network must comply with local rules and regulations.

Verify that there is an easy access to the main power switch and to the current leakage safety relay (GFCI). The voltage supplied to the device must comply with the label  $\pm 10\%$ .

### 1.11 Device Environmental Information

- The peak sound level generated by the autoclave is 67dBa with background noise of 48dBa during sterilization stage, and 65dBa during drying stage.
- The total heat per hour transmitted by the autoclave is <200Wh.

### 1.12 Requirements with concern to Water Quality

The distilled or mineral-free water supply to the autoclave shall be according to the table below:

#### Suggested Maximum Limits of Contaminants in Water for Steam Sterilization per EN13060

*Table 5 - Water Quality*

Substance	Feed Water	Condensate
Evaporate residue	$\leq 10$ mg/l	$\leq 1.0$ mg/l
SiO <sub>2</sub>	$\leq 1$ mg/l	$\leq 0.1$ mg/l
Iron	$\leq 0.2$ mg/l	$\leq 0.1$ mg/l
Cadmium	$\leq 0.005$ mg/l	$\leq 0.005$ mg/l
Lead	$\leq 0.05$ mg/l	$\leq 0.05$ mg/l
Rest of heavy metals except iron, cadmium, lead	$\leq 0.1$ mg/l	$\leq 0.1$ mg/l

Substance	Feed Water	Condensate
Chloride (Cl)	≤ 2 mg/l	≤ 0.1 mg/l
Phosphate	≤ 0.5 mg/l	≤ 0.1 mg/l
Conductivity (at 20°C)	≤15 µs/cm	≤ 3 µs/cm
pH value	5 to 7.5	5 to 7
Hardness	≤ 0.02 mmol/l	≤ 0.02 mmol/l
Appearance	Colorless, clean, without sediments	

Compliance with the above data should be tested in accordance with acknowledged analytical methods, by an authorized laboratory.



**Caution:**

**The use of water for autoclaves that do not comply with the table above may have severe impact on the working life of the sterilizer and can invalidate the manufacturer's guarantee.**

**Use only deionized water, having a maximum conductivity of 15 µs/cm. Conductivity greater than 15 µs/cm may cause failures.**

**1.12.1 Tap water supply**

**The range of hardness value 0.7-2.0 mmol/l (70- 200 mg/l CaCO<sub>3</sub>)**









**The use of soft water is strictly forbidden!**

**Please consult a water specialist!**

**Note:** We recommend testing the water quality once a month. The use of water for autoclaves that does not comply with the table above may have severe impact on the working life of the sterilizer and can invalidate the manufacturer's guarantee.

## 2. Safety

Table 6 - Safety warnings and precautions

 Caution!	<p>Always operate the autoclaves strictly as instructed in this user manual.</p>
 Caution!	<p>Instruments should not be loaded into the autoclave to be sterilized unless Steam Sterilization is instructed in their User Manual. The instructed Steam Sterilization Program should be verified against the programs available in this autoclave.</p>
 Caution!	<p>Never use the autoclave to sterilize corrosive products (acids, bases, or phenols) volatile compounds or solutions (ethanol, methanol or chloroform), or radioactive substances.</p>
 Warning!	<p>Always wear heat resistant gloves before unloading and avoid touching hot load and hot surfaces.</p>
 Warning!	<p>Don't place your hand or head, etc. above the door while opening it as hot steam is escaping the chamber.</p>
 Warning!	<p>Do not stand near the back panel of the autoclave while the device is operating as the pressure safety valve may release steam.</p>
 Warning!	<p>Do not touch hot surfaces, such as the top enclosure and area adjacent to the chamber opening! Hot surfaces are indicated with a label (see sec. 1.3 above)</p>
 Caution!	<p>Only technical personnel having proper qualifications and holding technical documentation (including a technician manual) and adequate information are authorized to install and serve the apparatus</p>
 Caution!	<p>In order to assure proper operation of the autoclave, it should not be placed in the vicinity of electrical equipment which is not certified for Electromagnetic Compatibility according to IEC/EN 61326-1.</p>

## **2.1 Safety Notes**

- All new autoclave users must undergo a period of training in proper usage under an experienced employee.
- Before initial use, check the autoclave chamber to ensure that no packaging materials have been left inside.
- Before use, check inside the autoclave chamber to ensure that no items have been left from the previous cycle.
- Always verify that you have chosen the appropriate sterilization program
- After the cycle, open the door slowly to allow steam to escape and wait 20 seconds before you remove the load.
- A certified inspector must perform a periodic pressure chamber safety test according to the local regulations.
- Once a year, or more frequently, effectiveness tests must be performed, i.e., calibration and validation.
- Make sure there are no leaks, breaks, blockages, whistles or strange noises.
- Perform maintenance operations as instructed. The owner of the autoclave is responsible to perform the maintenance operations.
- Notify the person in charge immediately of any deviation from the normal functioning of the device.
- Protective equipment and clothes and other safety instructions shall be implemented in accordance with local and national regulations and/or rules.

## 2.2 Safety features incorporated in the device

The pressure vessel chamber door has the following features protecting personnel from hazards:

- Two door switches indicate that the door is closed. Without this indication steam is not introduced into the chamber.
- An electrical door locking pin that blocks door opening during operation.

The following safety devices are installed in the autoclave to optimize its safe operation:

- Safety thermostat, to prevent over-heating of the chamber heating elements.
- Safety cut-off switch to prevent over-heating of the pipe heating element.
- Safety pressure valve to prevent over-pressurizing of the chamber.



**Warning!**

**Mind the Power socket. Keep it and its vicinity dry.  
Danger of electrocution.**



## 3. Content of the Device Package

Table 7 - Device Package

Part Number	Part Description	Quantity Supplied
AMS11-120-W-T/ AMS11-120-T	T-Edge 11-W Autoclave T-Edge 11 Autoclave	1
TRY510-0001	Aluminum Tray for 11"	5
TRH510-0001	Wire Tray holder for 5 trays or USA Cassettes-11	1
CMT240-0002	Tray Handle	1
PIP411-0042	Tube for Reservoir Drain	2
PIP511-0029	Tube with Angle Connector for Auto Reservoir Drain	1
FIL175-0176	Hose Seal With Filter, Mesh 60	1
GAS086-0102	Hose, Flexible, St. St, Nut End, RS331S12, Hydra 1/2"x200cm	1
WIR040-0232	Power Cable 15A 125VAC (USA)	1
CLE096-0072	Chamber Clean for B&S- Class 6 tablets - sample kit	1
03-134-05	Autoclave Calibration Report	1
MAN205-0502003EN Rev. C	Operation and Maintenance Manual (USA)	1
MAN205-0732EN	Quick Start Guide (English)	1
MAN205-1500000EN	Table-Top and Vertical autoclave log book	1

## 4. Depiction of System Parts

### 4.1 Front View

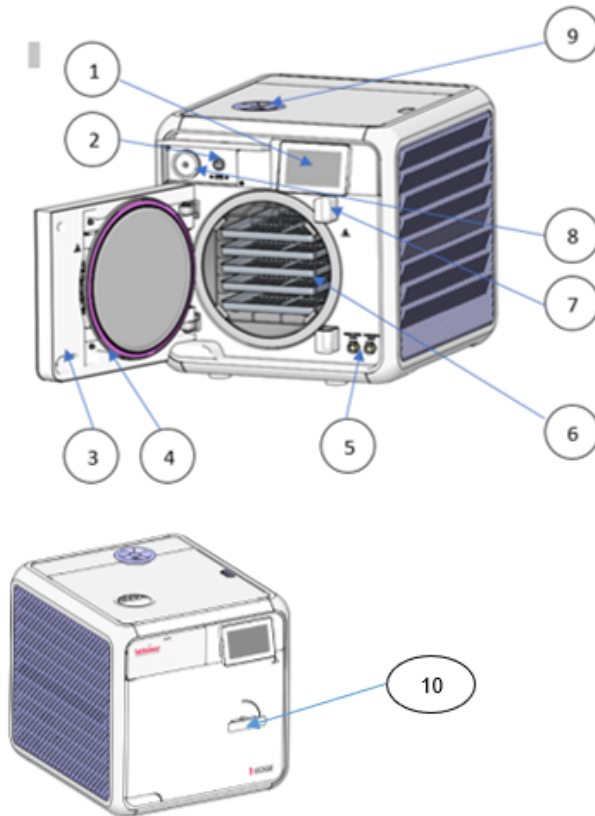

Table 8 - Front View

No.	Description	No.	Description
1	Touch screen	6	Chamber
2	ON/OFF switch	7	Door switches
3	Chamber Door	8	Air filter
4	Door Gasket	9	Mineral-free water reservoir opening
5	Mineral-free (left) and waste water (right) reservoir drains	10	Door Handle

## 4.2 Rear View

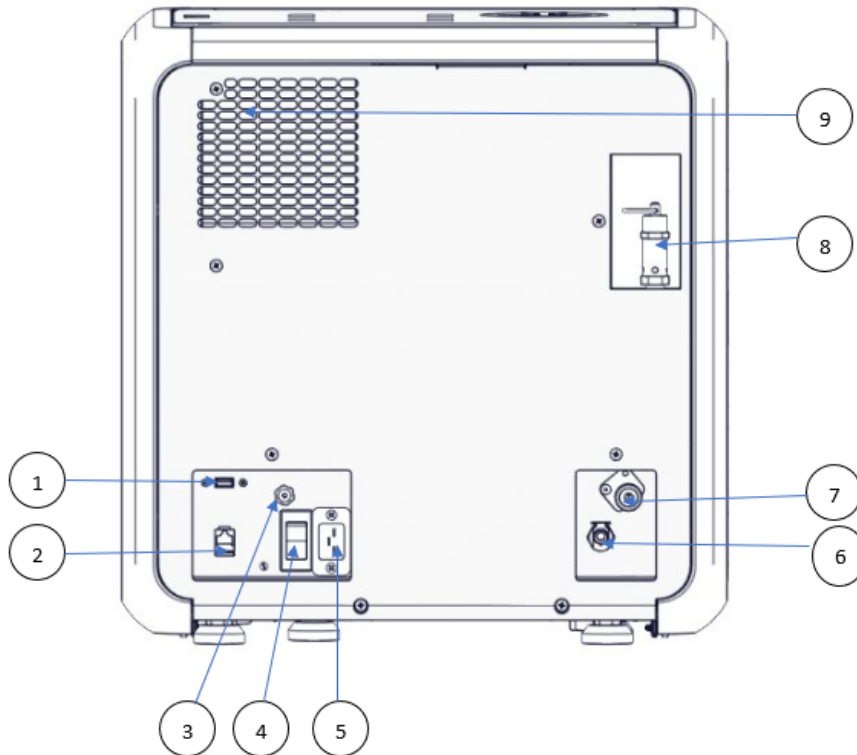

Table 9 - Rear View

No.	Description	No.	Description
1	USB ports	6	Waste outlet
2	LAN socket	7	Mineral-free inlet (available in AMS11-120-W-T)
3	Cut-off Thermostat	8	Safety valve
4	Circuit breaker on off switch	9	Aeration Ventilation opening
5	Power socket		



**Warning!**

**Mind the Power socket. Keep it and its vicinity dry. Danger of electrocution.**

---

## 5. Installation Instructions

---

### 5.1 Lifting and Carrying



#### **Cautions!**

**Before moving the autoclave, make sure that the electric cord is disconnected from the power, and there is no pressure in the chamber.**

**Drain the water from the reservoir (see Draining the Reservoirs)**

**Do not drop the device!**

To avoid injuries, lifting and carrying should be done with at least two people or by using a fork-lift or any other mechanical aid.

### 5.2 Device Placement and Operating Conditions

1. The autoclave is intended for indoor use only.
2. Check and verify that the counter carrying the autoclave is a rigid and leveled surface and can carry a load of 165 lbs (75kg).



**Caution! The device is not designed for use on any standard slide out shelf. If it is necessary to use a slide out shelf, it must be tested and/or rated for 165 lbs (75Kg) or more.**

3. Check and verify that the dimensions of the surface of the counter are at least 21"(55cm) x 23"(60cm).
4. Keep the back and the sides of the autoclave approximately 10cm away from the wall to allow ventilation and facilitate the device disconnection.
5. If placed in a cabinet, verify that the rear of the cabinet is open to allow ventilation.



**Caution! Insufficient space for ventilation may result in malfunction or damage due to overheating.**

6. It is recommended that enough space be left around the autoclave to give a technician access for servicing the machine.

7. Check and verify that the ambient temperature range is 41°F (5°C)-104°F(40°C), it is preferable not to exceed 86 °F (30°C).
8. Check and verify that the ambient relative humidity does not exceed 80%
9. The operational altitude shall not be over 13123 ft (4000 meters).
10. Ambient pressure shall not be lower than 8.8 psi (60.5 KPa) (if the altitude and temperature are kept in the manufacturer's instructed ranges above, and no forced extreme negative pressure is applied near the autoclave, then ambient pressure of 8.8 psi (60.5 KPa) or higher is guaranteed, as it is a function of altitude and temperature).
11. Operate the autoclave only in the manner specified in the manual. If the equipment is used in a manner not specified by the manufacturer, the protection provided by the equipment may be impaired.

### **5.3 Connections to Utility Supplies**

1. Check and verify that the power supply is a 1 phase, 120VAC ±10%, 60Hz, 15A supply.
2. Check and verify that the electrical net is protected by a current leakage safety relay.

### **5.4 Storage**

After the removal of the autoclave from the package, we recommend the following:

Keep the device dry.

Keep the device away from sunlight and protect it from heat.

## 5.5 Initial Operation of the Device

**Note:** Remove all packaging material before turning ON the device (see below).

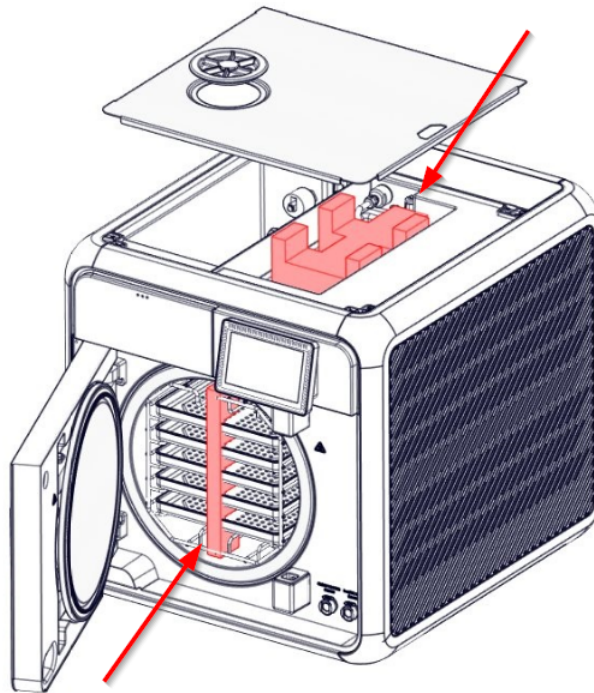

1. Plug the power cord into the power socket.

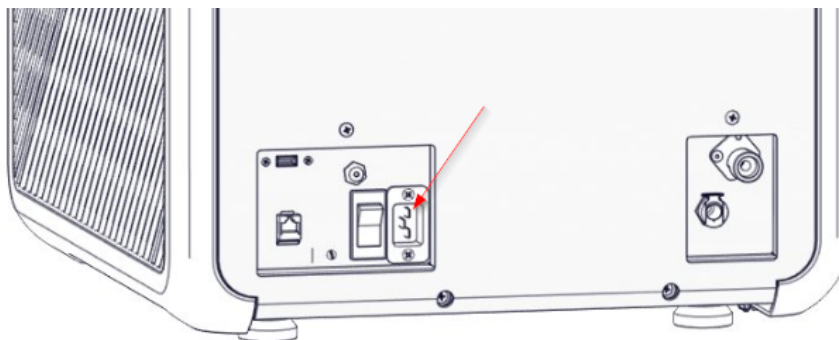

 <p><b>Warning!</b></p>	<p><b>Mind the Power socket. Keep it and its vicinity dry. Danger of electrocution.</b></p>
--	---

2. Turn ON the semi-automatic ON/ OFF button switch located on the bottom left side of the back panel of the autoclave (see the rear view).

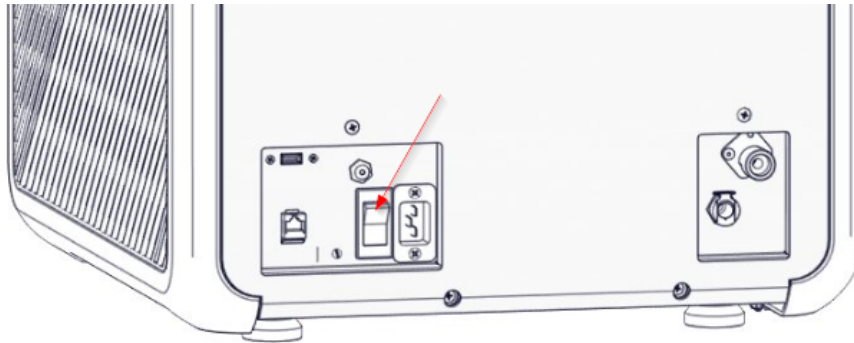

3. Turn on the ON/ OFF Switch mounted on the bottom left side of the front panel (see the front view).

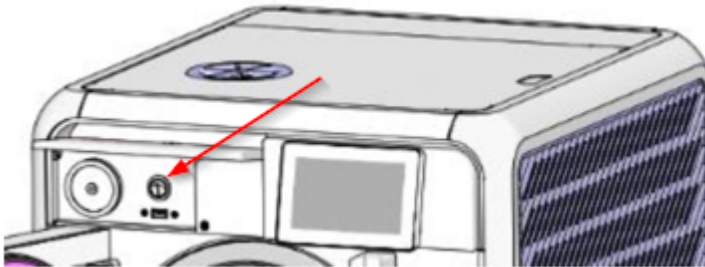

4. When you turn on the autoclave, it will automatically warm up.



**Warning!**

**Be careful the surfaces may be hot!**

5. Fill the Mineral Free Water Reservoir with water meeting the quality specs (see Water Quality and Filling the Mineral-Free Water Reservoir).
6. Set date and time (see Set date and time).

## 5.6 Before starting the Autoclave

### Important!

**Reset the Atmospheric Pressure prior to operating the Autoclave for the first time.**

To reset the Atmospheric Pressure:

1. Open the Autoclave door and verify that the Chamber's ambient temperature is below 113°F.
2. In the **Quick Option** screen, press the **Settings** icon , then browse to Maintenance/Reset atmospheric pressure.

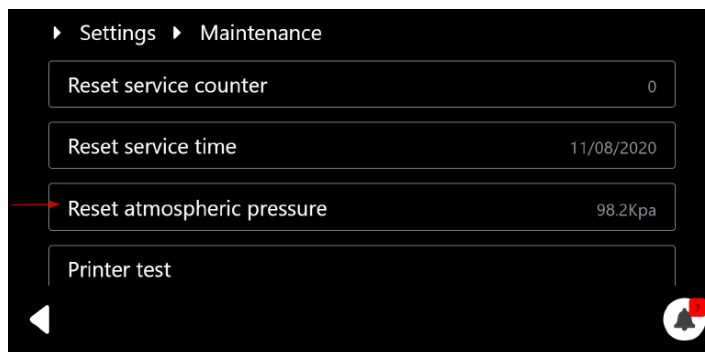

3. In the confirmation screen, press **Reset**.

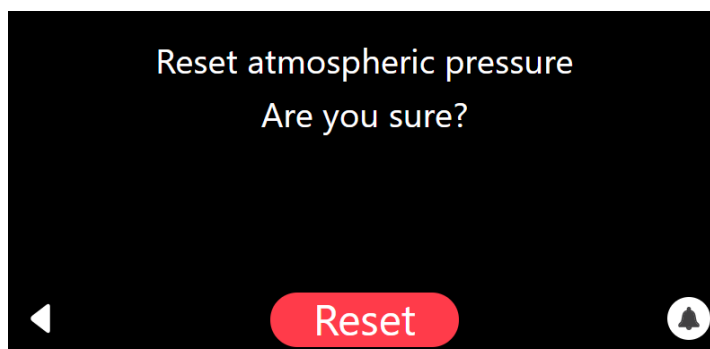

Before starting the autoclave we recommend that you check the following:

1. In the **Quick Option** screen, press the **Info** option.





2. Select the Version information.

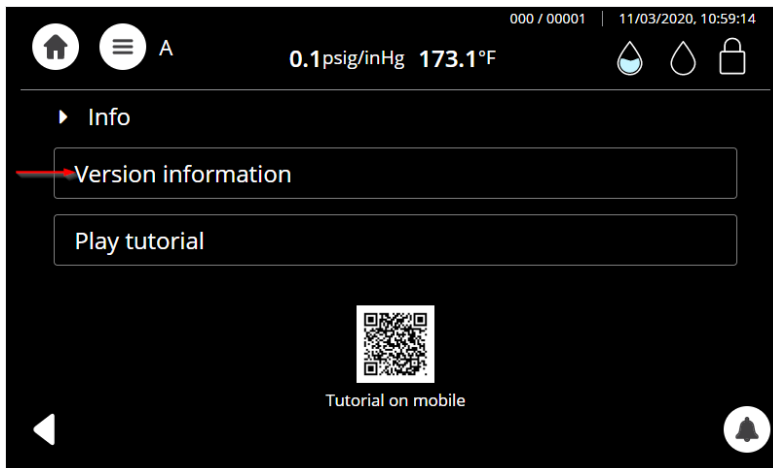

3. The Version information is displayed. For an example, see below:





4. Press on the  to return to the **Info** screen.
5. Select the **Play tutorial** option to watch the T-Edge 11 Instructional Video



6. The T-Edge 11 Instructional Video can be accessed in the link below:

<https://tuttnauer.com/t-edge10/en/video/how-to>

## 6. Pre-sterilization Cleaning and Disinfection of Instruments and their Loading into the Device

 <b>Caution!</b>	<b>Instruments should not be loaded into the autoclave to be sterilized unless Steam Sterilization is instructed in their User Manual. The instructed Steam Sterilization Program should be verified against the programs available in this autoclave.</b>
 <b>Caution!</b>	<b>Never use the autoclave to sterilize corrosive products (acids, bases, or phenols) volatile compounds or solutions (ethanol, methanol or chloroform), or radioactive substances.</b>

The most important stage begins with removing debris by cleaning and rinsing. Effective cleaning is affected by several factors: water quality, type, concentration and quality of a cleaner, effective washing method, and adequate rinsing and drying.

Cleaning dried blood is especially difficult because it flows and dries in difficult-to-clean locations. It shall be washed away. Mechanically scrubbing, high pH detergents, enzymatic solutions, and water spray at high pressure will clean this contamination.

**Note:** Consult the Medical Device manufacturer relating adequate and most effective cleaning method and cleaning agents.

Instruments which are composed of several components shall be dismantled.

**Disinfection** is the next step. It is important for safe handling. There are various methods and means for disinfection like soaking in liquid chemical disinfectants or hot water disinfection.

**Packaging.** The target in packing medical items is to assure that the contained goods are sterile and maintaining them sterile till opening the package.

There are various methods and techniques used in preparation and packaging of surgical instruments.

Check the instructions of the item manufacturer as to the proper procedure for cleaning and sterilizing each item. The item manufacturer's instructions always supersede any other instructions.

- Clean instruments immediately after use to remove any residue. It is recommended that all instruments be ultrasonically cleaned using Tuttnauer's Clean & Simple enzymatic cleaning tablets or other suitable solution.
- After cleaning, rinse instruments under tap water for 30 seconds and pat or air dry to remove residual minerals. If your tap water has a high mineral content, then rinse a second time in a bath of distilled water to remove minerals and pat dry.
- Launder textile wraps prior to sterilization, thoroughly rinse wraps laundered in chlorine bleach. Chlorine bleach can harm your stainless-steel instrument and the sterilizer.
- Follow the instrument manufacturer's instructions on the use of products for cleaning and lubricating instrument that have been ultrasonically cleaned.
- Be sure that instruments of dissimilar metal (stainless steel, carbon steel, etc.) are separated. Carbon steel instruments should be bagged or placed on autoclavable towels and not directly on stainless steel trays (mixing will result in damage to the instruments or trays from the oxidation of these materials).
- Load items within the boundaries of the tray so that they do not touch the chamber walls or fall off when the tray is moved. Items should not be allowed to touch the walls of the Chamber as the hot metal can damage the item.
- Don't overload the Sterilizer trays (see Specification). Overloading will cause inadequate sterilization & drying.
- Make sure that all instruments remain apart during the sterilization cycle. Surfaces that are hidden because items are covering other items will not be exposed to the steam and will not be sterilized.
- Disassemble or sufficiently loosen multiple-part instruments prior to packaging to permit the sterilizing agent to come into direct contact with all parts of the instrument.
- Verify that packaging methods are in accordance with the good practice approach and the packaging materials used are in agreement with applicable standards.
- Tilt on edge items prone to entrap air and moisture, e.g. hollowware, so that only minimal resistance to air removal exist, the passage of steam and condensate will be met.

- Wrapped instruments should be placed in material which will allow steam penetration and promote drying, such as autoclave bag, autoclave paper, or muslin towels.
- When loading pouches on the tray, put them with paper side up, nylon side towards the tray (see the figure below).

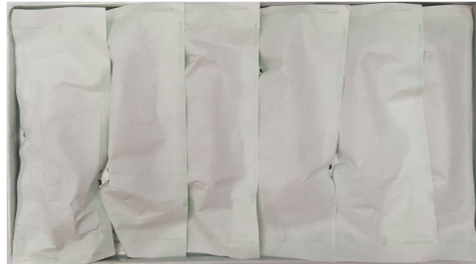

- Tubing should be rinsed after cleaning. When placed in the tray, make sure that both ends of the tubing are open and there are no sharp bends or twists.

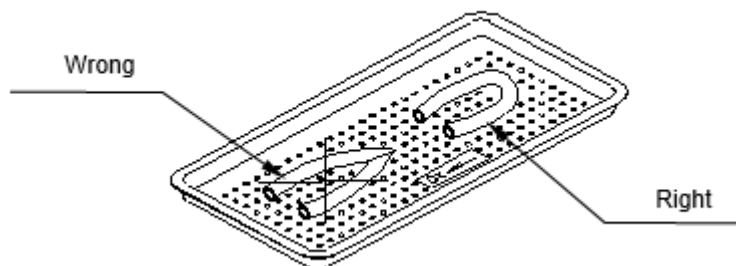

- Cassettes should be placed on the tray rack in place of the trays. They should not be touching each other or the Chamber walls. There should be about 1" (2.5cm) between cassettes or packs for proper steam circulation.
- If spotting is detected on the instruments it is necessary to determine if the spot is dirt or rust. The first step would be to use an ordinary eraser to remove the spot. If there is no pitting under the spot, then the spot is only dirt. Dirt spots on an instrument may be an indication that the autoclave needs to be cleaned or that the instruments were not adequately cleaned or dried prior to sterilization. If removal of the spot reveals pitting, then the spot is most likely rust. Rust spots on an instrument are not uncommon on inexpensive instruments. It may also be an indication that the instruments were rinsed in tap water with a high mineral content. These minerals when exposed to high temperature and steam will accelerate the oxidation of the metal. One suggestion would be to final rinse the instruments in a distilled water bath and pat dry to absorb residual water and minerals.

- If the instruments exhibit a discoloration this can be due to the mixing of carbon steel and stainless steel. When these two metals come into contact with each other electrolysis occurs that breaks down the metal. The best solution is to separately wrap the carbon steel instrument to insulate it from other instruments on the tray and the tray itself.

## 7. Operating Instructions

The following are the operation instructions.

### 7.1 Turning on the Device

Plug the power cord into the socket on the rear panel of the autoclave (see the rear view) and into the wall outlet.

Turn ON the semi-automatic ON/ OFF bottom Switch located on the rear panel of the autoclave (see the rear view).

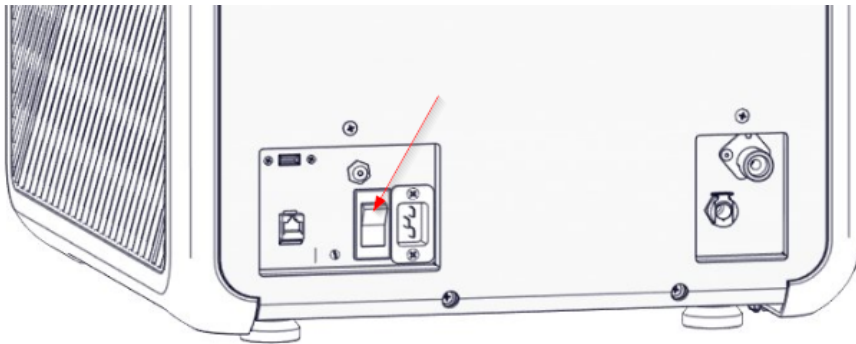

Turn on the ON/OFF switch mounted under the cover on the front of the autoclave (see below)

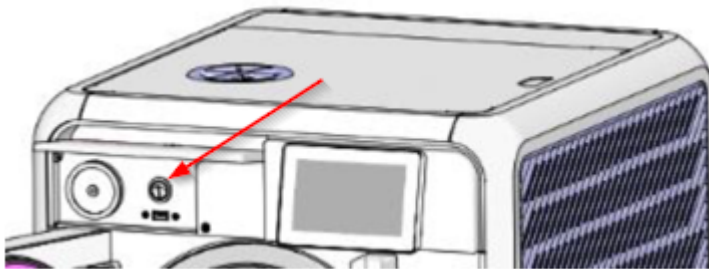

### 7.2 Filling Water





#### **Cautions!**

In the beginning of each day, check water level in the reservoir.

**Note:** Improper Water level icon  appears when the water reservoir needs to be filled. (See the filling procedure in section 7.3 and Draining the Reservoir procedure in section 8.11).

A general alarm symbol  will appear.

Proper Water level icon  appears when the water reservoir is properly filled. (See the filling procedure in section 7.3 and Draining the Reservoir procedure in section 8.11).

The water level icon  appears when the water level in the reservoir is full. (See the filling procedure in section 7.3 and Draining the Reservoir procedure in section 8.11). **When this icon appear, do not fill water!**

**Note: A new icon was added to the row of icons for the dirty water reservoir**



The following screen shows that the Waste water tank is full.

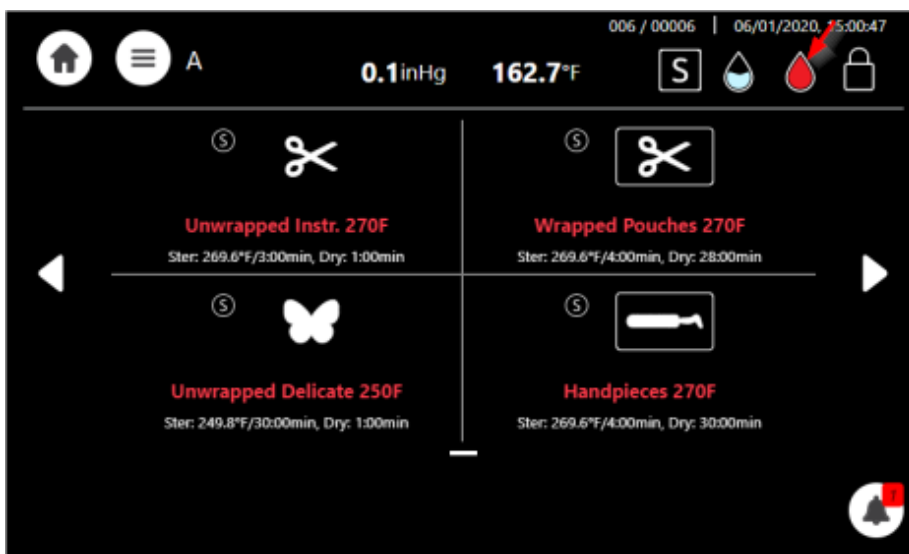

The following screen shows that the Waste water tank is empty.



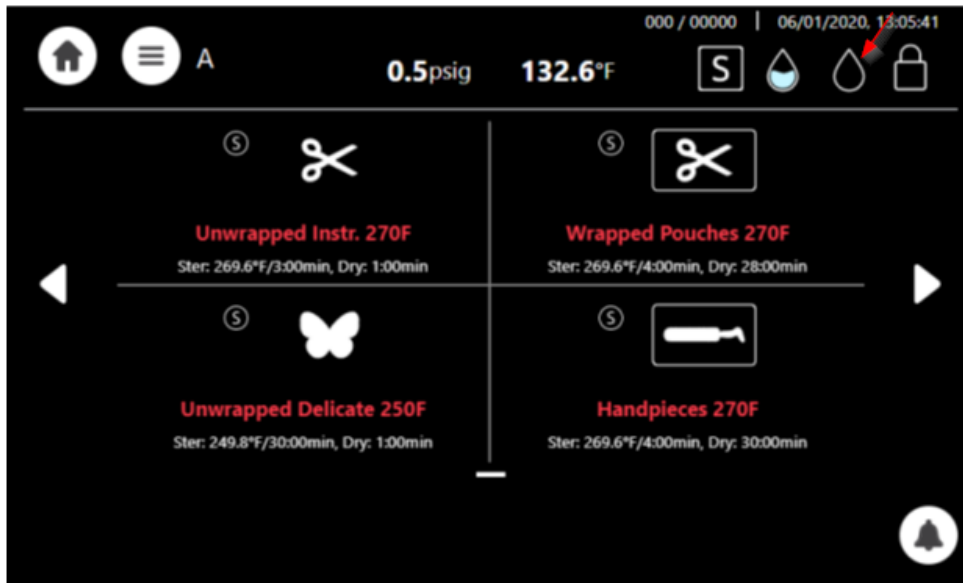

**Caution!**

Before filling the reservoir, verify that the autoclave is idle and there is no pressure in the chamber.

**7.3 Filling water in the reservoir**

**Note:** Use only water having the characteristics stated in Water Quality. Using tap water will clog the system and invalidate the manufacturer’s guarantee.

To fill water in the reservoir:

Lift up the water reservoir cover (see below).

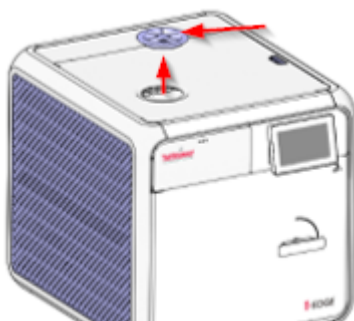

Pour water into the reservoir through the water filter on top of the autoclave unit.

In case you fill too much water, it will spill on the counter.

The clean water level indicator will change from a red water droplet symbol to a blue water droplet, as shown below:

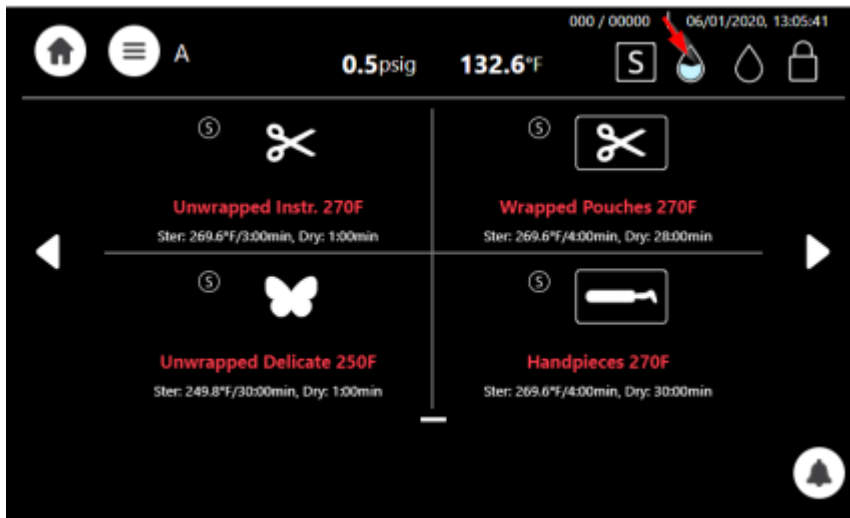

The screen below displays a full clean water tank.

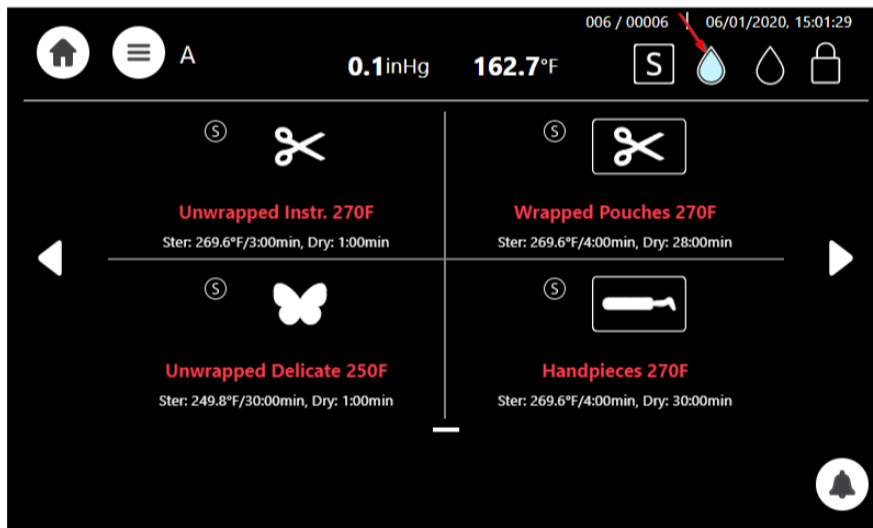



## 7.4 See the requirements concerning Water Quality, in Section 1.12

## 7.5 Setting Date and Time

**Note:** The Initial log-in including setting of drying time as well as other initial parameters will be performed only by a qualified technician upon installation

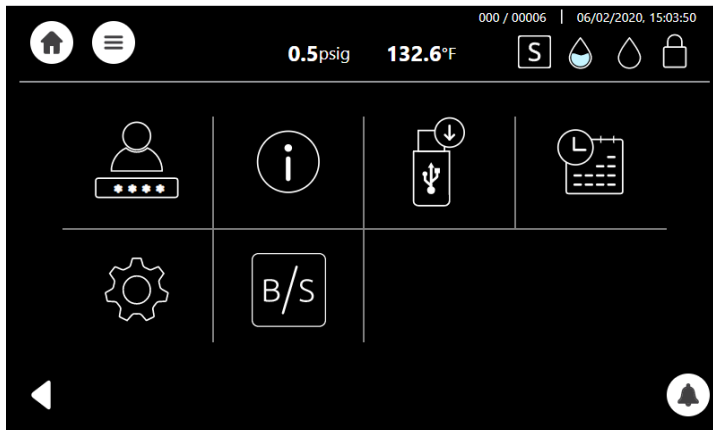
On the main screen, press the menu symbol  to open the **Quick Option** screen.



From the **Quick Option** screen, select the Set Date and Time icon .

**Note:** The only functionality to be performed by the user (on a regular basis) is setting the date and time.

Select day, month and year, as depicted:

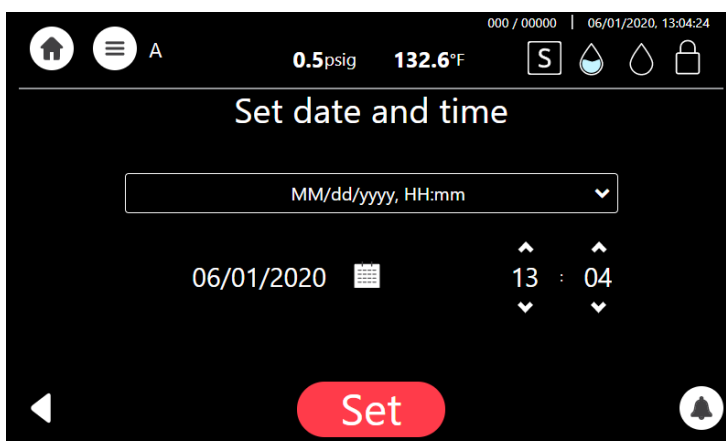

After adjusting the date and time, the system will automatically restart.

## 7.6 Class S and Class B

### **Class B: General description**

Class B (that conform to European standard) mainly provides deeper vacuum in the autoclave chamber than Class S, and therefore include more complete air removal from the most difficult load types. It allows the system to perform vacuum in difficult hollow or porous instruments and perform effective sterilization of these materials.

### **Class S: General description**

Class S used in the USA obtain weaker vacuum level and is less effective than Class B in the sterilization of hollow instruments.

The following tables provide:

**Table A** for types of sterilization cycles

**Table B** provides the T-Edge 11, Class B sterilization programs.

**Table C** provides the T-Edge 11, Class S sterilization programs.

**Table A — Types of sterilization cycles**

Class B	Class S
<p>The sterilization of products as represented by the test loads in the standard.</p> <p>For products that lie within the limits specified for the relevant test loads, this includes:</p> <p>solid products</p> <p>porous products and lumen devices</p> <p>wrapped (single and multiple-layer) or non-wrapped</p>	<p>The sterilization of products as specified by the manufacturer of the sterilizer including non-wrapped solid products and at least one of the following:</p> <p>porous products, small porous items</p> <p>lumen devices, bowls and receivers</p> <p>single-layer wrapped products</p> <p>multiple-layer wrapped products</p>

**Table B — Class B: sterilization cycles**

	<b>Cycle Name</b>	<b>Sterilization Temp.</b>
<b>1</b>	Pre / Post Vac Unwrapped Instr. 273F	273°F
<b>2</b>	Pre / Post Vac Wrapped Pouches 273F	273°F
<b>3</b>	Pre / Post Vac Unwrapped Delicate 250F	250°F
<b>4</b>	Pre / Post Vac Wrapped Delicate 250F	250°F
<b>5</b>	Chamber Clean	
<b>6</b>	Bowie and Dick	273°F
<b>7</b>	Vacuum test	

**Table C — Class S: sterilization cycles**

	<b>Cycle Name</b>	<b>Sterilization Temp.</b>
<b>1</b>	Unwrapped Instr. 270F	270°F
<b>2</b>	Wrapped Pouches 270 F	270°F
<b>3</b>	Unwrapped Delicate 250F	250°F
<b>4</b>	Handpieces 270F	270°F
<b>5</b>	Chamber Clean	N/A

## 7.7 Setting Class S and Class B

Your autoclave contains Class S as a standard. If you (the customer) would like to upgrade your system to a Class B, please contact Tuttnauer USA representatives or your dealer. Tuttnauer will ask you for the autoclave serial number. In return Tuttnauer will provide you with a code/password.

After entering the new code password by the customer user, the autoclave will contain now the Class B features.

The following details the procedure to access Class B and how to switch from Class S to B, and from Class B to S.

1. From the **Quick Option** screen press  to select Class B.



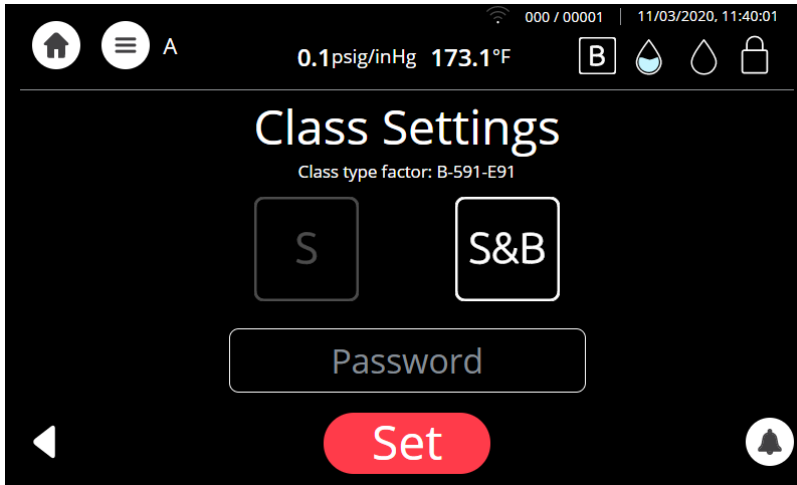

**Note:** The autoclave presently is in Class S.

2. Press on the required class  type.
3. The **Class Settings** screen is displayed, and the Class B is now displayed.

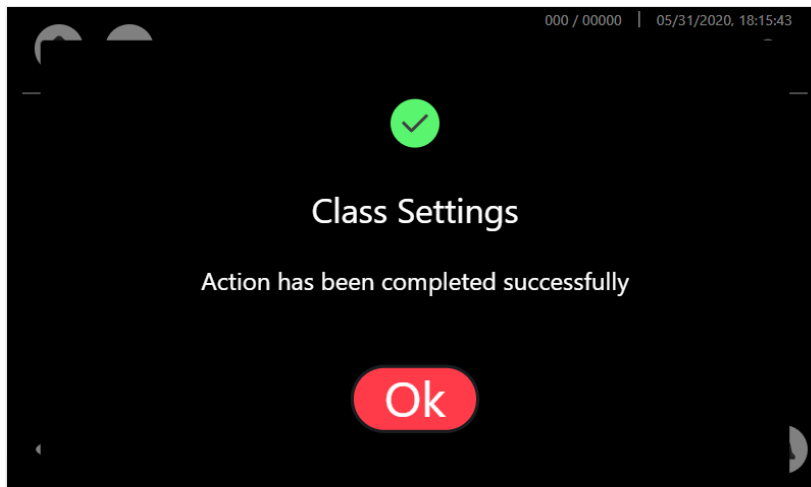

4. Enter **Password**.
5. Click on .
6. A **Class Settings** message will appear confirming the action completed successfully.



7. Press  to complete conversion.

The autoclave is now converted to Class B and the screens displayed will have a Class B identification.

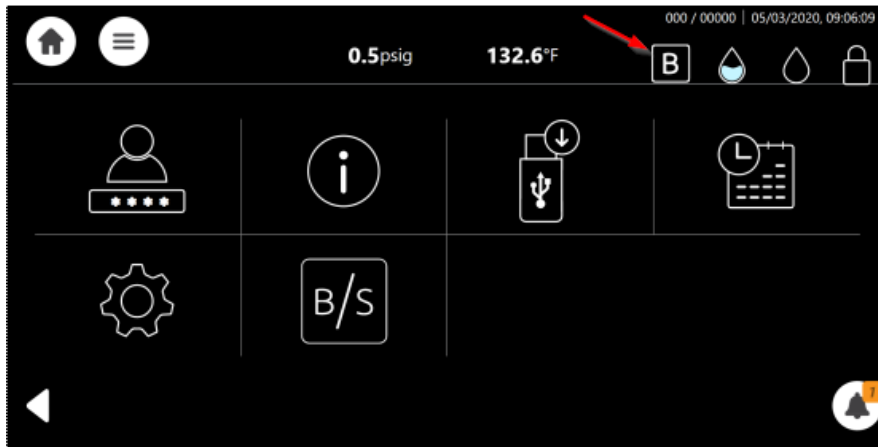

**Note:** The Class B sign is on the screen header.

The entire autoclave is now in Class B system, a sample of the screens after the conversion to Class B, are shown below:

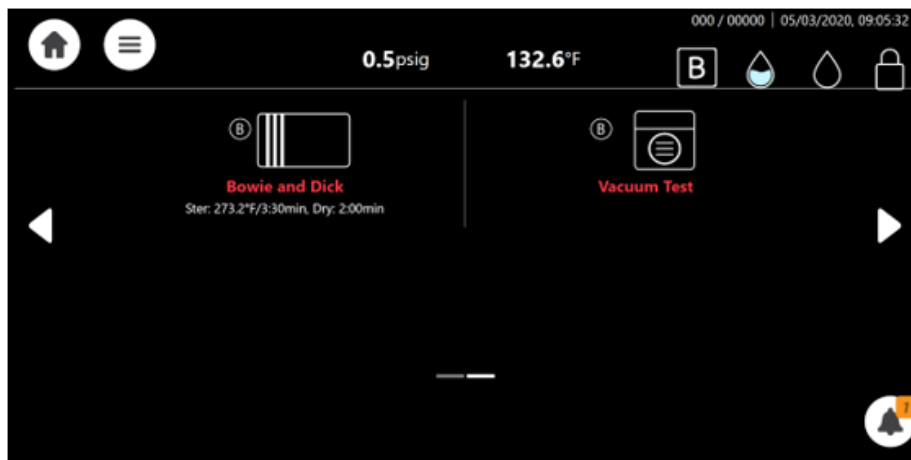
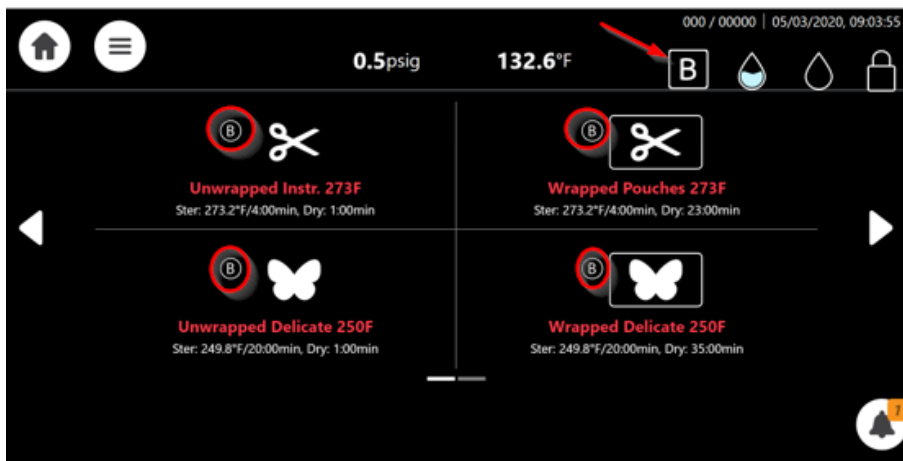



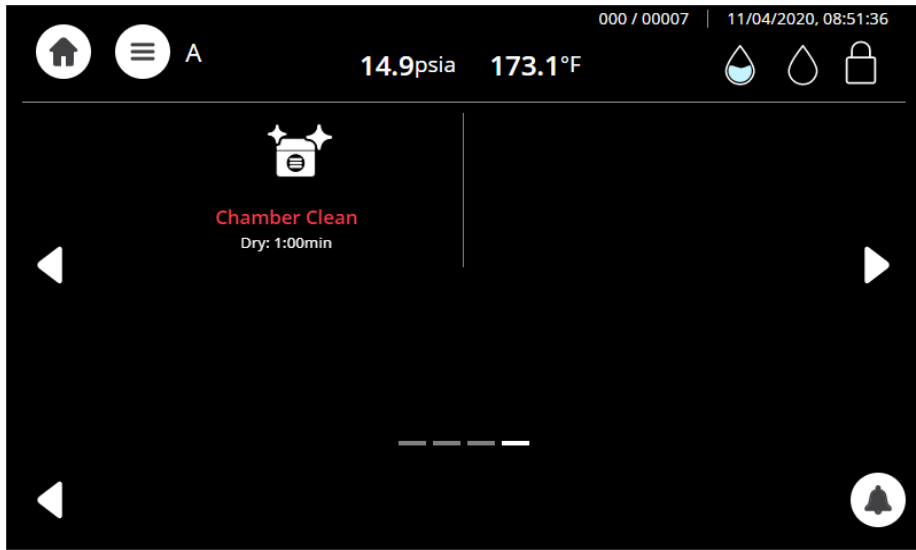

**Note:** It is possible to switch back from Class B to Class S if desired, following the steps above, by selecting S in step 3 above instead of S&B. Entering the code password is required.

## 8. Control Panel

The display is a graphic Touch screen LCD panel used to display the autoclave current status, any Operational or Error Messages and for operating the machine.

**Image 1: Home screen –Program Select Screen**

This screen will be presented when the autoclave is switched on:

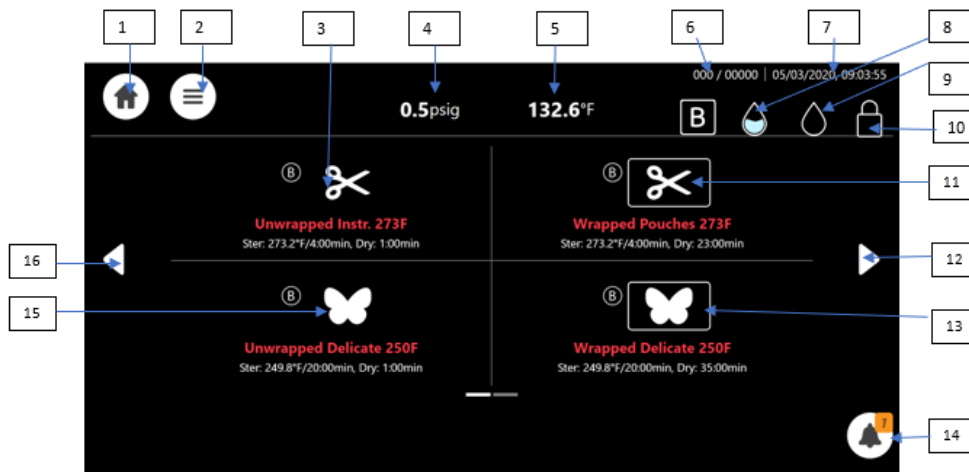



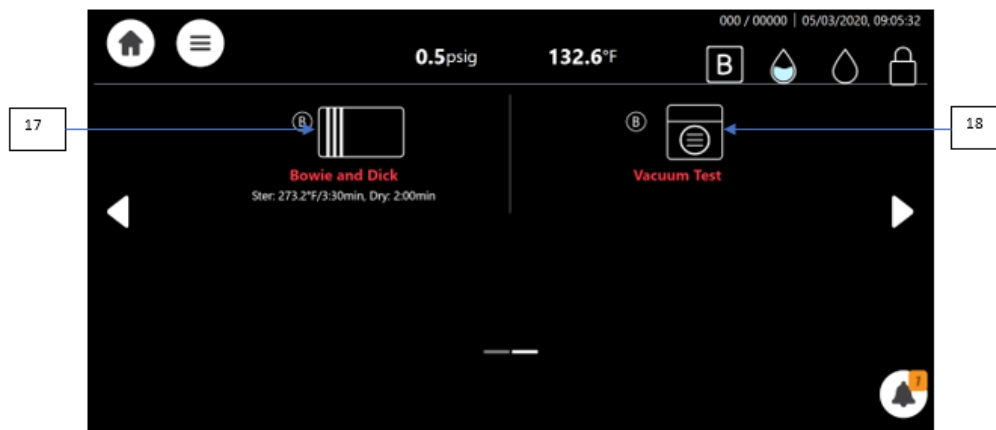











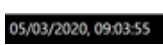







Additional programs are accessible by paging using the side arrows:



## 8.1 Home screen Description and Functions

Table 10 - Screen description and functions

#	Icon	Name	Description
1		Home icon	Immediate use only
2		Menu	Menu selection icon
3		Unwrapped 273F	Exposed Unwrapped 273°F load program
4		Pressure	Momentary Pressure in the chamber
5		Temperature	Momentary temperature in the chamber
6		Load no. ID	Load cycle number
7		Date and time	It enables the operator to set the machine date and time screen
8		Full water level (clean water tank)	The Water is full in the reservoir
9		Empty water level (waste water tank)	The Water is empty in the waste reservoir
10		Door condition	Door is closed
11		Wrapped Pouches 273F	Wrapped Pouches 273°F sterilization program
12		Side arrow right	Paging forward to the next program will display the next screen item 17, and 18

#	Icon	Name	Description
13		Wrapped Delicate 250F	Wrapped Delicate 250°F load program
14		Warnings	It indicate the Alerts
15		Unwrapped Delicate 250F	Unwrapped Delicate 250°F program
16		Side arrow left	Paging backward to the previous programs
17		Bowie and Dick Test	periodic testing as referred to in ISO 17665-1. See the screen in the top next page
18		Vacuum Test	See the screen in the bottom previous page
19		Chamber Clean	Chamber Clean program cleans the autoclave chamber
20		Custom	Duplicates a sterilization program and enables modifying the settings. <b>Note: This is not an FDA approved program!</b>
21		Virus Protect	The Virus Protect program is selected prior to a sterilization program to ensure that viruses are eliminated.
22		Add Extra Dry Time	Enables the option of adding extra dry time to a program

#	Icon	Name	Description
23		Start Cycle By Clock	Gives an option of starting a cycle by clock

## 8.2 Opening the Device Door

This machine is equipped with an electronic door lock. The door is locked when either the system is running a sterilization cycle, or there is pressure in the chamber, or the power is off.

If you need to open the door after cycle completes, press the confirm button:

Showing Class S

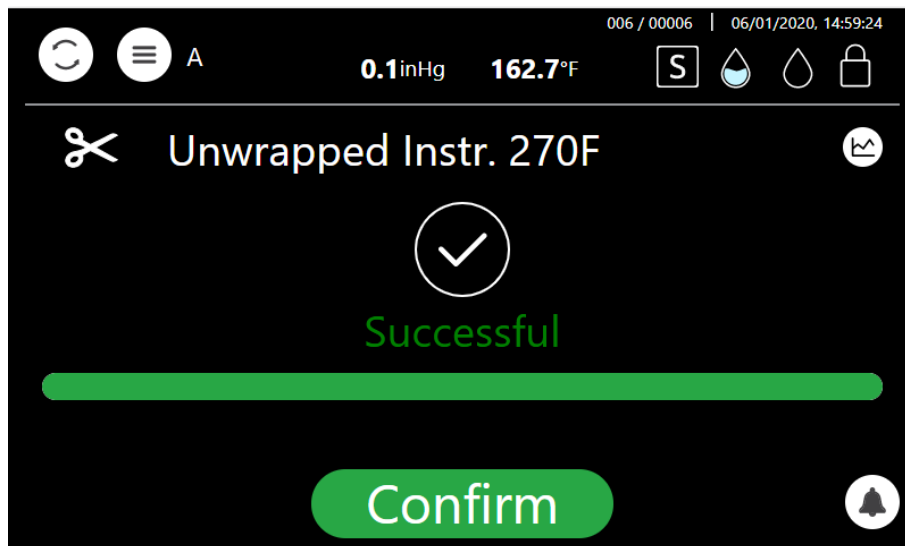

In any case, if the door is not locked, it can be opened as illustrated below.

Turn the handle counterclockwise and pull out to open the door.

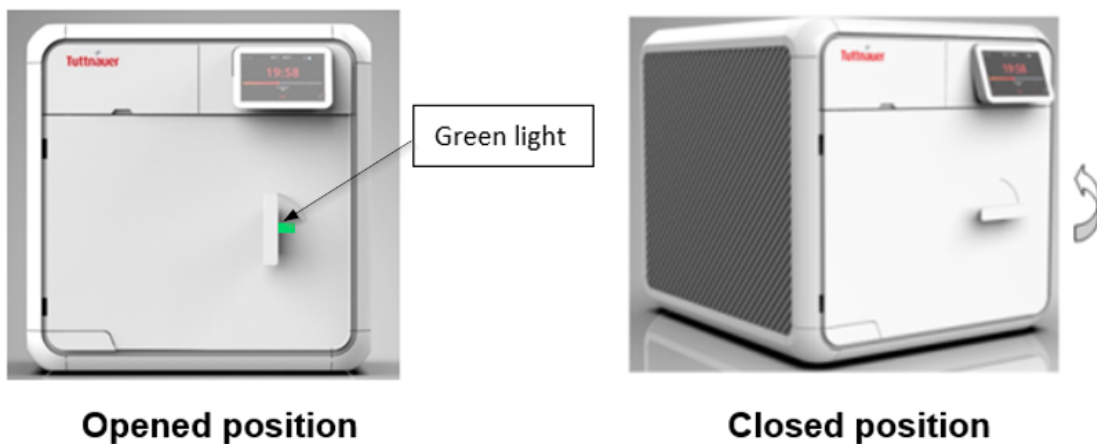

### 8.3 Starting a Cycle

It is recommended to perform B&D test cycle at the beginning of each working day.

1. Before each cycle, check visually that the gasket is intact, not loose and clean.
2. Load the autoclave properly (see chapter 6).
3. Choose the appropriate sterilization program.
4. Each sterilization program screen contains a Virus Protect  option.

**Notes:**

- The program can only be selected when the door is open.
- The Virus Protect is not for use for Textile and Porous programs

5. The selected programs are shown below:

**Class B**

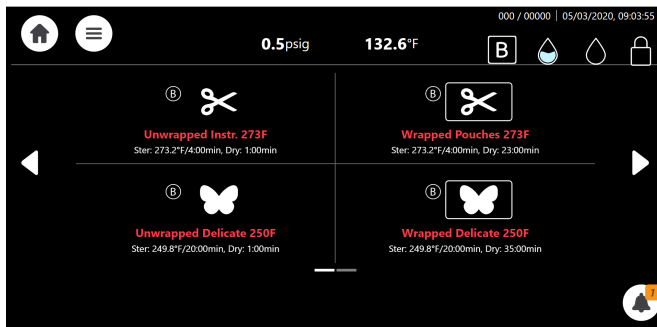

**Class S**

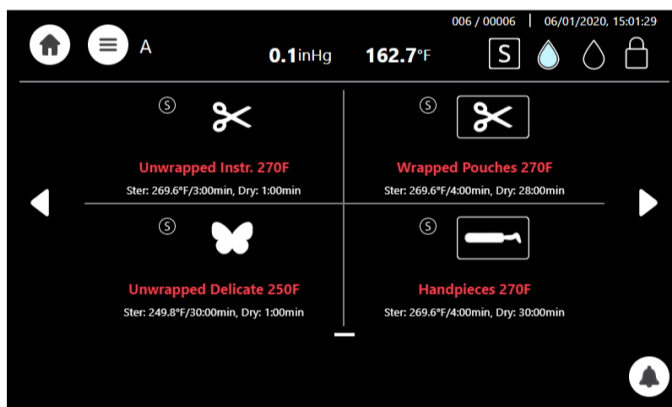

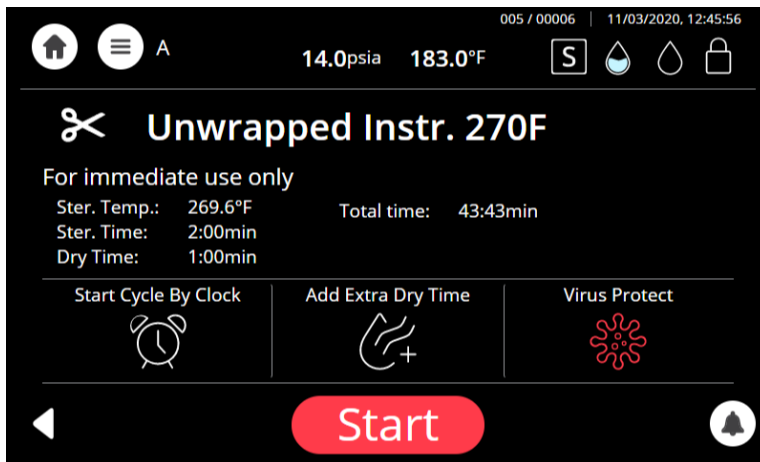

See section 8.5 for available sterilization and test programs.

6. The next screen will prompt the selected program information.



7. Close the door by both:

- Pushing the door gently;
- Turning the handle clockwise while pushing the door until it comes to the closed position, then releasing the handle.

When the door is closed, the open-door symbol  is replaced with the closed-door symbol .

8. Press the Start button  to start the cycle.

For cycle process description, see Sterilization Cycle Description.



**Warning!**

**Do not remove the top cover during a running cycle. Hot water / steam may exit!**

**After pressing start, the sterilization process starts**

**Image 3: screen display while "Unwrapped 134" sterilization program is in progress**

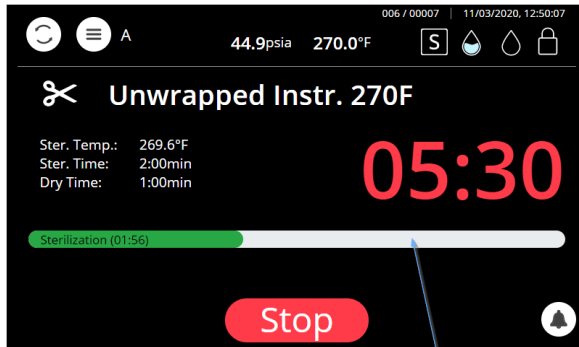

Showing the time left until the end of the process

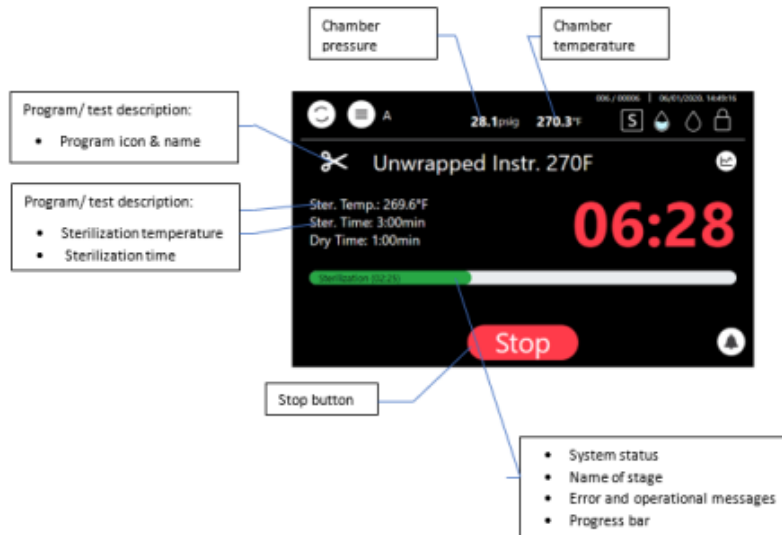

**Note: For the results of the cycle, see description in section 8.5**



## 8.4 Virus Protect program

The **Virus Protect**  is a program that eliminates viruses and is performed prior to a sterilization cycle.

**Note: The Virus Protect is not for use for Textile and Porous programs.**

1. Select from a sterilization cycle, the **Virus Protect** option.

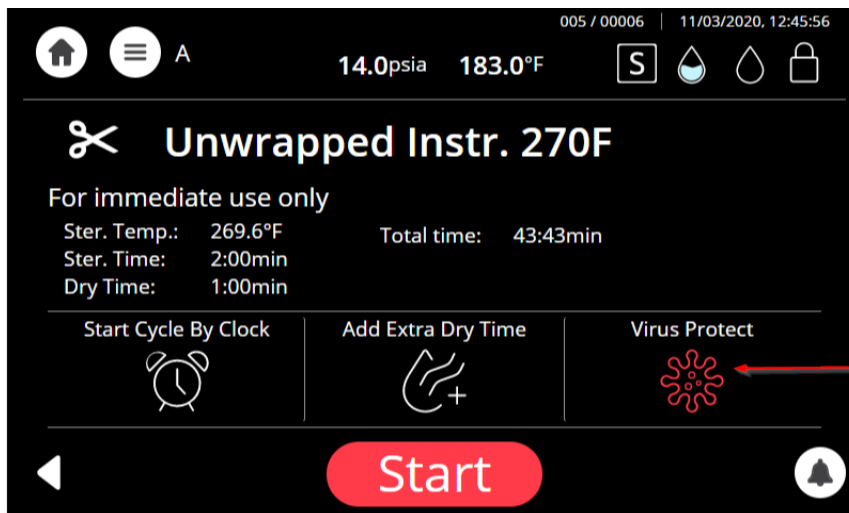

2. Raise the temperature to 230°F (110°C) and wait for a period of 10 minutes, for the Virus Protect process to complete and if, for example, the Unwrapped Instr. sterilization program is selected, the screen below is displayed if the virus protect is successfully completed.

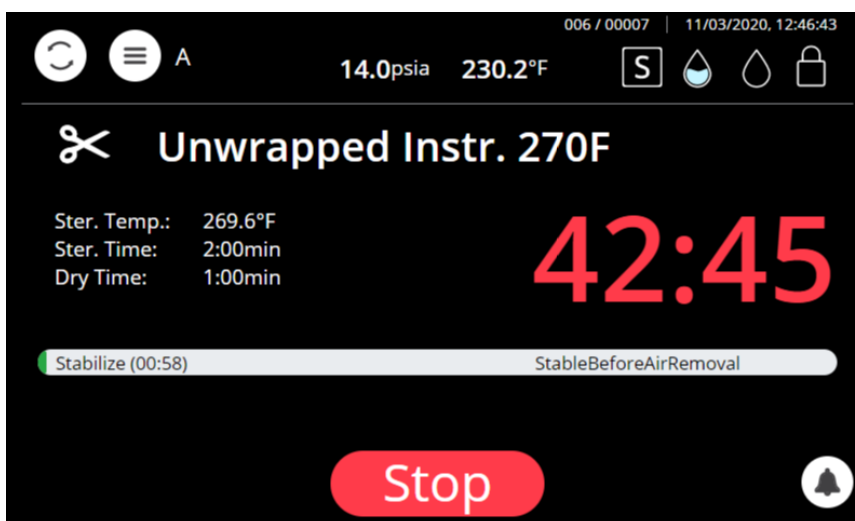



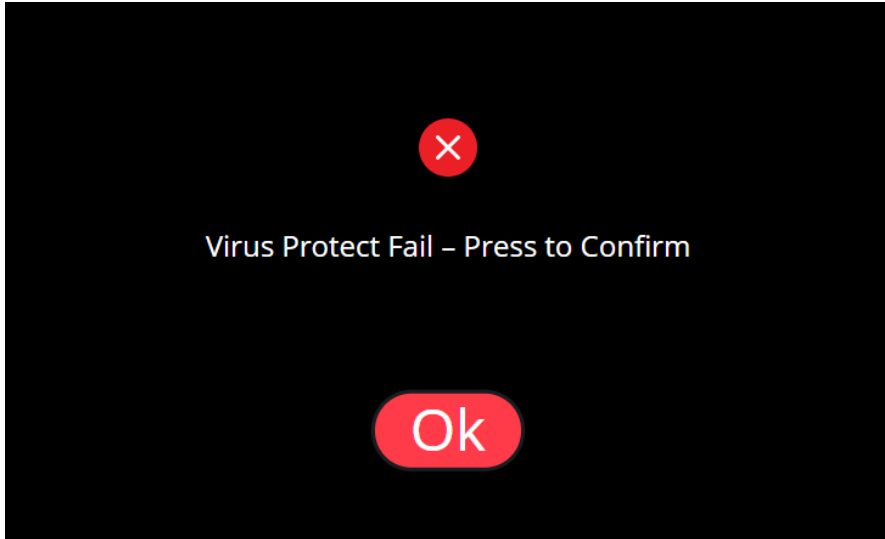



**Note: If the Virus Protect program fails, the confirmation message below appears. After pressing on OK in this message, the system will release air outside of the autoclave.**



## 8.5 Available Sterilization Programs and Test Programs





### 8.5.1 List of available Sterilization and Test Programs Class B

#	Icon	Name	Temp	Sterilization time (minutes)	Dry time (minutes)	Load type	Type of use
1		<sup>1</sup> Unwrapped Instr. 273F	273.2°F	4	2 (default) Range: 1-99	Unwrapped Instruments (Unwrapped Solid)	Immediate use only
2		Wrapped Pouches 273F	273.2°F	4	22 (default) Range: 16-99	Handpieces, Wrapped Instruments (wrapped solid), Textile (fabric packs), porous	For storage
3		<sup>1</sup> Unwrapped Delicate 250F	250°F	20	2 (default) Range: 1-99	Unwrapped Instruments (Unwrapped Solid)	Immediate use only
4		Wrapped Delicate 250F	250°F	20	33 (default) Range: 20-99	Wrapped Instruments (wrapped solid), Textile (fabric packs), porous	For storage
6		Bowie and Dick	273°F	3.5	2 (default) Range: 0-99	Chemical Indicator in a product challenge device	Periodic testing as referred to in ISO 17665-1
7		Vacuum Test	N/A	N/A	Vac. Stable Time 1 = 5min Vac. Time stable 2 = 10min	Empty	Not Applicable
8		Chamber Clean	273°F	N/A	N/A	Empty	Periodic cleaning

#### Notes:

The Unwrapped sterilization program can be used for sterilizing lumen device of no longer than 9" (230mm) and no smaller than 0.13" (3.4mm).

## Class S

#	Icon	Name	Temp	Sterilization time (minutes)	Dry time (minutes)	Load type	Type of use
1		Unwrapped Instr. 270F	269.6°F	3	2 (default) Range: 1-99	Unwrapped Instruments (Unwrapped Solid)	Immediate use only
2		Wrapped Pouches 270F	269.6°F	4	30 (default) Range: 25-99	Handpieces, Wrapped Instruments (wrapped solid), Textile (fabric packs), porous	For storage
3		Unwrapped Delicate 250F	249.8°F	30	2 (default) Range: 1-99	Unwrapped Delicate Instruments (Unwrapped Solid)	Immediate use only
4		Handpieces 270F	269.6°F	4	30 (default) Range: 16-99	Handpieces	For storage

### 8.5.2 Maximum Load Weight per Load type

#### Class B

Load type	Maximum Load Weight	Suitable for programs
Textile, porous	~4.4 lbs (2.0kg)	Wrapped
Solid Unwrapped	~20 lbs (9.0kg)	Unwrapped
Solid Wrapped	~12 lbs (5.4kg)	Wrapped

#### Class S

Load type	Maximum Load Weight	Suitable for programs
Solid Unwrapped	~17.6 lbs (8.0kg)	Unwrapped
Solid Wrapped	~9.9 lbs (4.5kg)	Wrapped

### 8.5.3 Description of the Sterilization Cycle Stages

**Air-removal stage:** Pre vacuum pulses are performed. For wrapped cycles, there are 2-3 pulses and the vacuum are deeper.

**Heating stage:** steam is inserted into the chamber until the sterilization temperature is reached

**Sterilization:** sterilization temperature is maintained constant during the sterilization time.

**Fast exhaust:** steam is exhausted out of the chamber at a fast rate until pressure decreases to ambient pressure.

**Drying:** performed with the door closed by pulling vacuum and using the accumulated heat in the chamber and the load to remove leftover moisture from the instruments and wraps.

#### 8.5.4 Description of the Vacuum Test Stages

Vacuum is produced in the chamber, down to P1=2.17 psi (15 kPa.) At this stage all the valves close. The autoclave remains in this stage for 5 minutes. This period enables the condition in the chamber to reach equilibrium. After the 5 minutes have elapsed, the cycle 'history record' records the pressure that is referred to as P2. At this point the test begins and lasts 10 minutes. At the end of the test, the cycle 'history record' records the results. The pressure at the end of the test is referred to as P3.

#### Notes:

- During the test period the autoclave is not heated. Even if the vacuum test is completed, the operator shall check the test results and consider whether the test results are acceptable or not.
- Perform the Vacuum Test on a completely dry chamber. Preferably following a cycle with a Drying procedure i.e., a Wrapped cycle, and after the Chamber was cooled i.e., Sleep mode/Turned off.

#### 8.5.5 Description of Bowie-Dick Test Stages

**Air-removal stage:** vacuum pulses are performed.

**Heating stage:** steam is inserted into the chamber until the sterilization temperature and pressure are reached.

**Sterilization stage:** temperature and pressure are maintained constant at the pre-set level for sterilization time.

**Fast exhaust stage:** steam is exhausted out of the chamber at a fast rate until pressure decreases to ambient pressure.

**Drying stage:** heating of chamber followed by a vacuum break (air inlet) to remove leftover moisture from the instruments and wraps. Air inlet to reach atmospheric pressure.

## 8.6 Cycle Succeeded / Cycle Failed Notifications and Follow-on

### 8.6.1 Cycle Succeeded

When the cycle has ended successfully, the following "Successful" message is displayed:

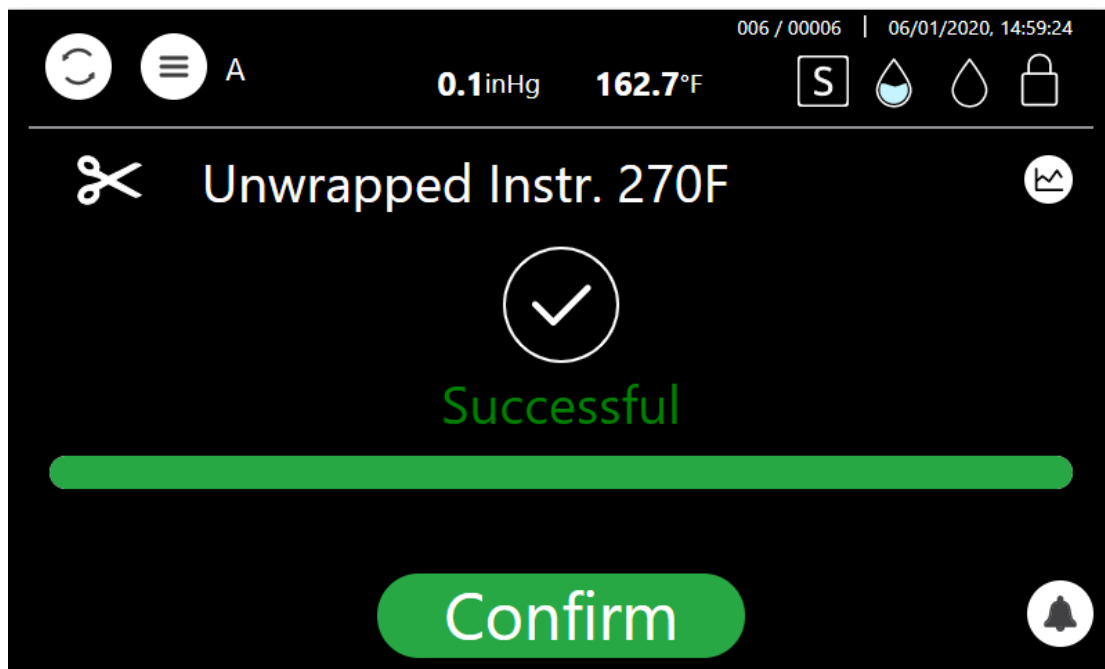

Push the confirm button  to confirm the "Successful" message. Proceed to chapter "Opening the door and Unloading".

### 8.6.2 Cycle Failed

In the event of a failure at any stage, the exhaust valve will be opened to release pressure from the chamber, the message "Fail" and a relevant failure message will be displayed on the screen:

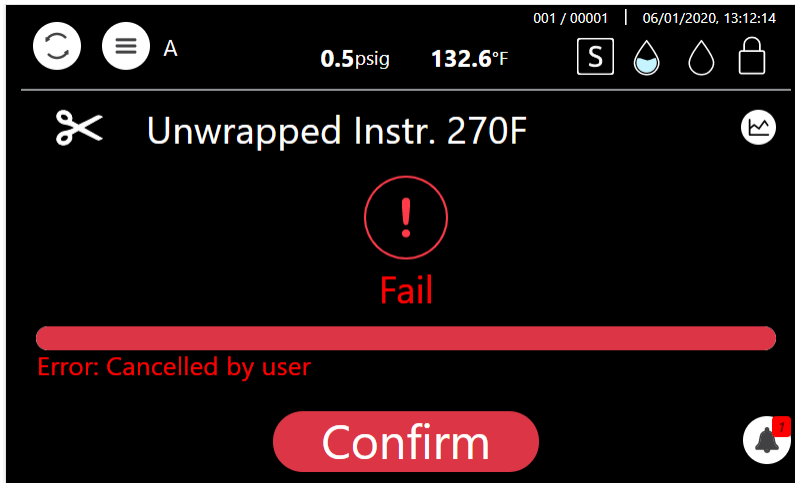

**Warning!**

The load has not completed a sterilization cycle; therefore, it is not sterile. Handle it as a contaminated load.

Any failure means that the load is not sterile.

## 8.7 Aborting a cycle

It is possible to stop the cycle while the autoclave is operating. Press the Stop

button  at any stage (except exhaust) of the process to stop the operation.

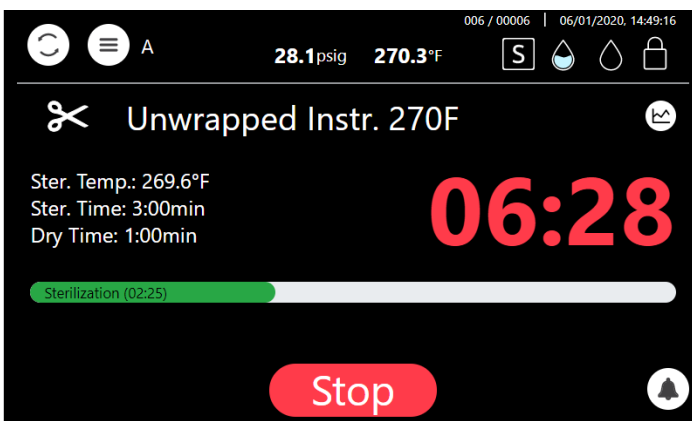

If the cycle is aborted, the load is not sterile. A “fail” message will be displayed

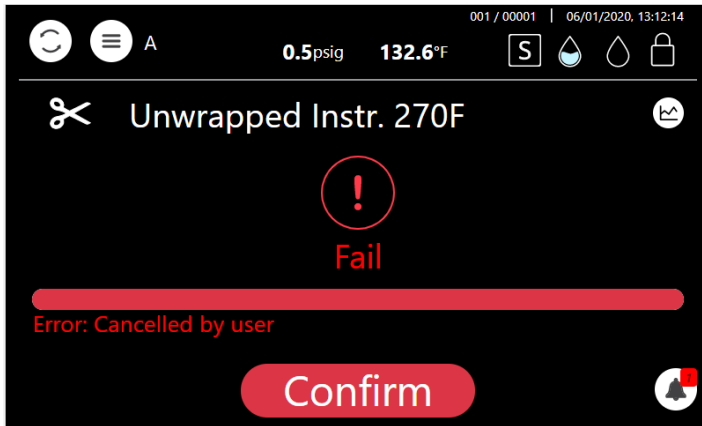

with an error message explaining the reason for the failure. An alternating buzzer signal will sound to notify the user.

Press the  button to confirm the displayed message.



**Warning!**

**The load has not completed the cycle; therefore, it is not sterile.  
Handle it as a contaminated load.**



## 8.8 Custom Programs



**Custom programs are not FDA approved!**

**Validation of the sterilized cycle is the user's responsibility.**

T-Edge 11 offers the user a customized program, adjusted in order to sterilize items that cannot be sterilized in any of the preceding default programs.

To utilize a customized program:

Have your dealer or service technician create a customized program. This can be done by duplicating one of the preinstalled programs.

The new program becomes a customized program with a new name (per

customer's request), a unique icon , and specific settings are available for modification.

1. Select from the Home screen, the Custom program.

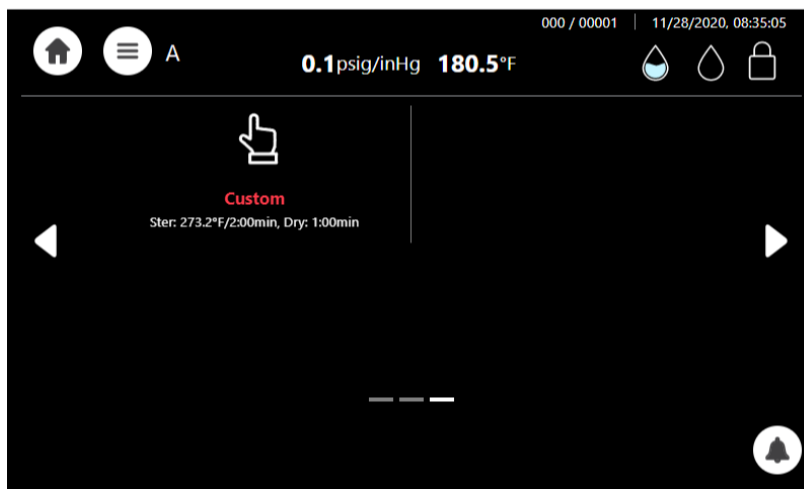

2. The Custom program is displayed below with the modified settings.

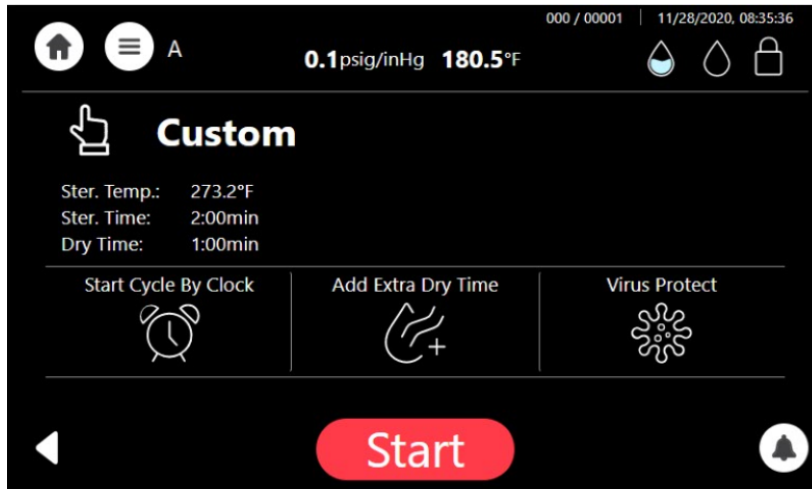

3. Press **Start** to begin the customized cycle.

## 8.9 Cycles history

The Cycles history menu enables printing a specific cycle.

- On the Quick Option screen, press the Settings icon , then browse to Advanced options / Handle cycles / Cycles history

The following screen is displayed with the status of the cycle.



If you select a cycle history from the screen above, a Cycle content screen appears

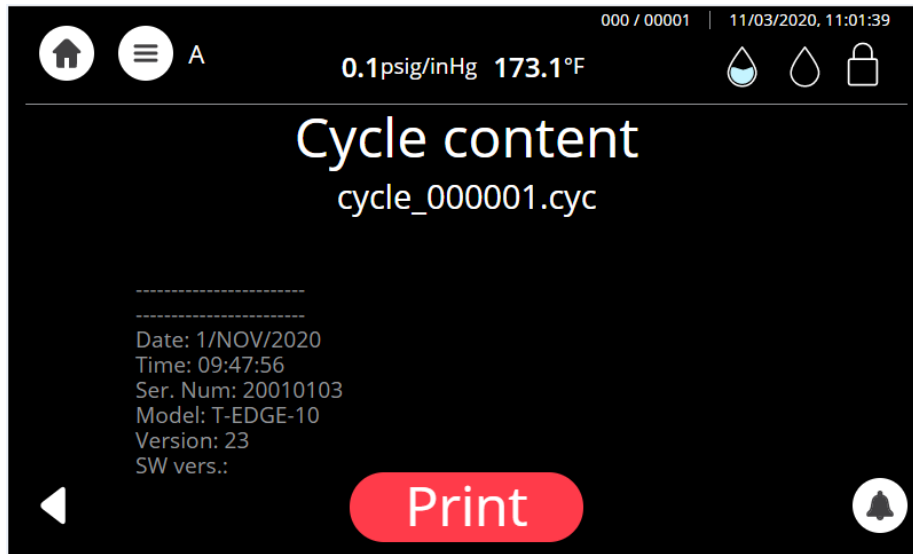

Press  to receive the entire printout of the selected cycle history.

## 8.10 Opening the door and Unloading

A red button with the word "Confirm" in white text.

1. Push the  button to confirm the "Successful" or the "error" message to unlock the door.
2. Open the door.



**Caution!**

**Open the door a little to release the steam from the chamber. Only after the steam escaped, open the door widely.**



**Warning!**

**To avoid severe injuries from hot steam and condensed hot water that may drip out when opening the door, it is strictly forbidden to lean on the autoclave. It is strictly forbidden to place your hand or any part of your body over or under the door.**

3. Use the tray handle or wear heat-resistant gloves to remove the load from the autoclave.
4. After unloading, visually inspect the load to ascertain that it is dry, and that sterilization indicators have made the required color change.



**Caution:**

**Water droplets and visible signs of moisture on sterile packaging or the tape used to secure it, may compromise sterility of processed loads or be indicative of a sterilization process failure. Visually check outside wrapper for dryness. If there are water droplets or visible moisture on the exterior of the package or on the tape used to secure it, the pack or instrument tray is considered unacceptable.**



**Warning!**

The sterility of the instruments processed in unwrapped cycles cannot be maintained if exposed to non-sterile environment.

### 8.11 Checking Waste Water Level



When the waste water level is high, the general alarm symbol will appear. A relevant text alarm will appear in the alarms list. This situation is normal, but the operator cannot run a new cycle before draining the waste water reservoir (see Draining the Reservoirs in section 8.11).

### 8.12 Draining the Reservoirs

This procedure applies to the mineral-free water reservoir (left) and to the waste-water reservoir (on the right).



**Note:** Improper Water level icon  appears when the water reservoir needs to be filled or drained .

The drain valves are located on the front right side of the autoclave after the door is opened.

**To drain the reservoir:**

1. See item (5) with the plastic hose (6) attached to it (supplied with the autoclave).

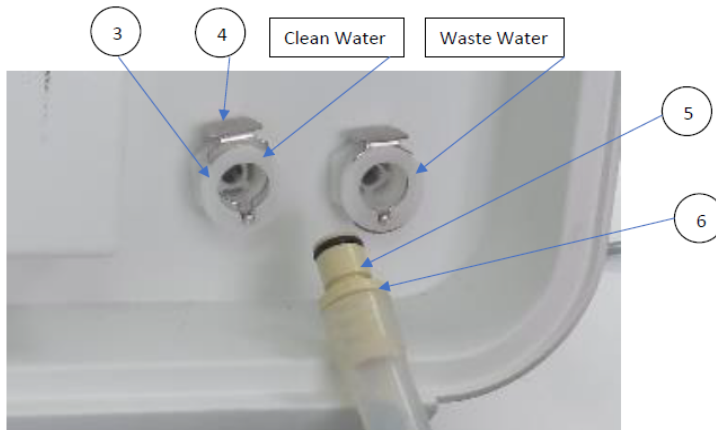

2. Put the other end of the hose into a drain bucket.
3. Insert part (5) into valve (3) and press it until you hear a click. The drain valve opens immediately.
4. When the water reservoir is empty, press part (4). Item (5) will pop out approx. 1/8"(3mm) and the drain valve will be closed. Remove item (6) with the plastic tube.



**Caution!**

**Never reuse waste water.**

5. If the drained reservoir is the clean-water reservoir, fill reservoir with distilled water until it reaches the full level. (Approximately 219 Ounces /6.5 liters).

The autoclave is now ready for use.

#### 8.12.1 Waste water draining



**Caution!**

**Waste water should be brought into the public net in accordance with the local rules or requirements i.e ONLY NON-HAZARDOUS LIQUIDS SHALL BE DISPOSED IN PUBLIC SEWAGE!**

Connect the autoclave's drain to the building's drainage pipe. The drainage shall be of an open type, withstanding temperature of, at least, 140°F. (Applicable for device with automatic water inlet system only).

## 9. Preventive and Scheduled Maintenance to be performed by the Operator

---

The maintenance operations described in this chapter need to be followed as indicated to keep the device in good working condition and to keep any breakdown time to a minimum.

The instructions that follow can easily be carried out by the operating personnel and do not require a service technician.

Should the need arise, technical assistance or a service technician can be requested by either calling your dealer or Tuttnauer U.S.A.

### 9.1 Daily Maintenance



**Caution!**

**Make sure the autoclave is not hot before cleaning it.**

- Turn the unit on momentarily to allow the door to be opened. Open the door, unplug the autoclave again, and proceed with cleaning.
- Clean door gasket with a mild detergent, water and a soft cloth or sponge. Check visually that the gasket is intact, not loose and clean.

### 9.2 Weekly Maintenance



**Caution!**

**Make sure the autoclave is not hot before cleaning it.**

- Turn the unit on momentarily to allow the door to be opened. Open the door, unplug the autoclave again, and proceed with cleaning.
- Clean the outer parts of the autoclave with a soft cloth.

#### 9.2.1 Chamber Clean

Once a week perform chamber clean process per section 12

## 9.3 Monthly Maintenance



**Caution!**

**Make sure the autoclave is not hot before cleaning it.**

- Turn the unit on momentarily to allow the door to be opened. Open the door, unplug the autoclave again, and proceed with cleaning.
- Clean and descale the chamber.
- If the autoclave is only used occasionally, drain the water from the mineral free water reservoir once a week, and refill with fresh mineral-free water or distilled water.
- Once a week or if a text alarm of 'full waste water reservoir' appears (whichever comes first) drain the water from the waste water reservoir.
- Clean the outer parts of the autoclave with a soft cloth.
- Clean the Drain filter of the autoclave.

## 9.4 Periodic Maintenance



**Caution!**

**Make sure the autoclave is not hot before cleaning it**

1. Replace the air filter, every 6 months or after 1000 cycles (whichever comes first) according to section 12.2.
2. Every 3 months check the door gasket for any signs of physical damage and ask the technician to replace it if there is tear or leakage.

### 9.4.1 Replacing the Air Filter

**Before proceeding, make sure that the electric cord is disconnected and there is no pressure in the chamber.**

**Use scissors to open the filter bag and not sharp blades or pointed instrument.**



**Check that the new filter has not exceeded the maximum shelf life.**

**Cautions!**

**Carefully un-pack the new filter and examine it for any signs of damage.**

**Remove any protective packaging before inserting the filter into place.**

**Carefully Insert the new filter into the housing. Do not force.**



The AIR filter is located under the mounted under the cover.



1. Unscrew the filter.

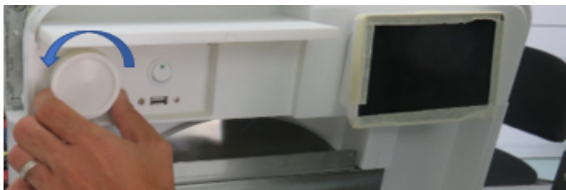

2. Disconnect the pipe.
3. Connect the new filter.



4. Screw in the new filter.
5. Ensure the new filter is all the way in and seated properly.

**Note:** Make sure that the arrow on the filter body points inwards, toward the chamber. Make sure that you don't bend the filter pipe when reattaching it.

**Note:** Replace the air filter every 6 months or after 1000 cycles (whichever is the shorter period).

## 9.4.2 Cleaning the Drain Filter



### Cautions!

**Make sure the autoclave is not hot before cleaning it**

**Before proceeding, make sure that the electric cord is disconnected and there is no pressure in the chamber.**

1. Clean the drain filter every month.

The DRAIN filter (1) is located inside the autoclave chamber at the bottom far end, to reach the filter open the autoclave chamber door, remove the tray (see below).

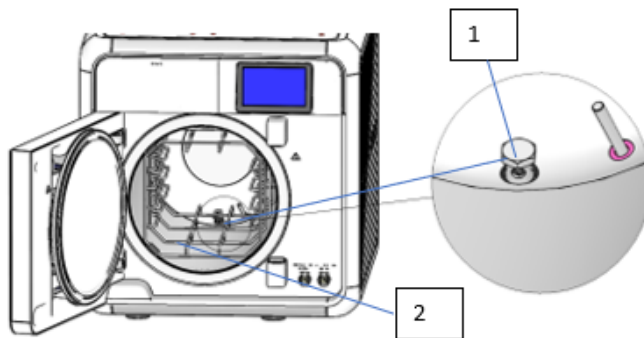

2. Open the autoclave chamber door, remove the tray (2), (see above).
3. Clean with a soft cloth the filter and the area around the filter.



4. Check that the autoclave function normally after the drain filter cleaning.

**Note:** If by cleaning the filter the result is not satisfactory, proceed to the replacement of the drain filter (paragraph 9.4.3 below).

### 9.4.3 Replacing the Drain Filter

**Note:** If after successive cleaning of the filter the result is not satisfactory proceed to the replacement of the drain filter (paragraph 9.4.3 below).

Before proceeding, make sure that the electric cord is disconnected and there is no pressure in the chamber.

Use scissors to open the filter bag and not sharp blades or pointed instrument.

Check that the new filter has not exceeded the maximum shelf life.



**Cautions!**

Carefully un-pack the new filter and examine it for any signs of damage.

Remove any protective packaging before inserting the filter into place.

Carefully Insert the new filter into the housing. Do not force.



**Caution!**

**Make sure the autoclave is not hot before cleaning it**

The DRAIN filter (1) is located inside the autoclave chamber at the bottom far end, to reach the filter open the autoclave chamber door, remove the tray (see below).

1. Replace the old DRAIN filter, by the new DRAIN filter (P/N: CMT511-0048).
2. Open the autoclave chamber door, remove the tray (2), (see below).

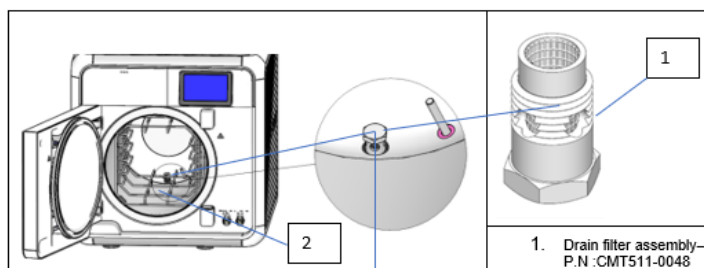

3. Unscrew the old Drain filter assembly, using M14 wrench.



4. Remove the old Drain filter assembly.
5. Screw the new Drain filter assembly, (P/N: CMT511-0048) to its place in the chamber bottom, tighten it with the M14 wrench.
6. Ensure the new filter is all the way in and seated properly.
7. Place the shelf (2) back.







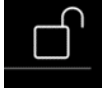

# 10. Full List of Informative Screen Display Symbols, Operating Messages, Error Messages and Troubleshooting

The troubleshooting section is provided in order to enable the user to solve minor malfunctions, prior to contracting our service department.

However, only technical personnel having proper qualifications and holding technical documentation (including a technician manual) and adequate information are authorized to serve the apparatus (See tables below).

## 10.1 Symbols

Symbol / Message	Symbol / Message Description	Required Action (if applicable)
	<p>This symbol is displayed when the door is open.</p> <p><b>Note:</b> The inherent safety feature of the machine enables the user to choose a cycle only when the door is open.</p>	Informative symbol ----
	<p>This symbol is displayed when the door is closed.</p> <p><b>Note:</b> The machine has an inherent safety feature that prevents the cycle from starting if the door is not closed.</p>	Informative symbol ----
	<p>Full water level (Clean water tank)</p>	Informative symbol ----



Symbol / Message	Symbol / Message Description	Required Action (if applicable)
	Low water level (Clean water tank)	Informative symbol ----
	Full water level (Waste water tank)	Empty the waste water reservoir
	Low water level (Waste water tank)	Fill the mineral free water reservoir until this symbol changes to the Good level symbol.
	Good water level (Waste water tank)	Informative symbol ----
	Alert	Press to watch the alert description
	When cycle is selected it is highlighted in red	----
	The "cycle succeeded" message and symbol are displayed when the cycle ends successfully.	----
	The "cycle Failed" message and symbol are displayed when the cycle failed either due to intended cycle abort action by the user, or due to a run-time error.	Try performing a new cycle in order to sterilize the load.

## 10.2 Error messages & Troubleshooting

Message	Description
"Door is Open"	In STBY stage, when Door switch (DI 1) Open AND Door lock DO 2 is ON
"Analog Input Error"	This message is displayed when any Temperature sensor or Pressure sensor is disconnected or out of range.  * The name of the input should appear in the message
"Chamber temperature not in range"	This message is displayed if the temperature in the chamber > End temperature (248°F) or < 35.6°F
"Chamber pressure not in range"	This message is displayed if Chamber pressure <ATM pressure-0.4 bar or >ATM Pressure +0.1 bar).
Cancel	
"I/O card is not connected"	This message is displayed if I/O card is disconnected (both while cycle is running or not).
"Low Temp"	This message is displayed if the temperature drops for more than 1 second below the sterilization temperature during sterilization cycle.
"High Temp"	This message is displayed if the temperature raises 37.4°F above sterilization temperature during the sterilization stage for 2 seconds during sterilization cycle.
"High Temp. (Ending)"	This message is displayed if the system cannot reach the required temperature, in the chamber, within 10 minutes.
"Heat Time Error"	This message is displayed if the system

Message	Description
	cannot reach the required temperature, in the chamber, within the preset time.
"Low Pressure"	This message is displayed if Chamber Pressure drops below the sterilization pressure for 2 seconds during the sterilization stage.
"High Pressure"	This message is displayed if Chamber Pressure raises 0.29 bar above sterilization pressure for 2 seconds during the sterilization stage.
"High Pressure (Ending)"	This message is displayed if the system cannot reach atmospheric pressure $\pm$ 0.05 bar during the ending stage.
"High Pressure (Exhaust)"	This message is displayed if the system cannot reach preset pressure within 10 minutes from the beginning of the exhaust stage.
"Pressure Time Error"	This message is displayed if the system cannot reach the required pressure conditions in the chamber, after preset time, during the air removal stage.
"Time Error"	This message is displayed if the real time clock is faulty.
"Door is open (During the cycle)"	This message is displayed when the door is open: During the cycle.
"Canceled By User"	This message is displayed after the STOP button is pressed and cycle aborted.

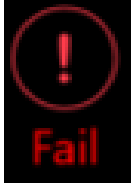

Message	Description
	<p>This message and symbol are displayed if an error occurs before sterilization cycle is completed.</p>
<p>"Air Error"</p>	<p>This message is displayed at the end of the cycle if the autoclave does not reach the atmospheric pressure after 10 minutes.</p>
	<p>If the water level is low in the clean water reservoir and not sufficient for at least one cycle, this symbol will be displayed. Mineral free water reservoir empty will appear in the error messages.</p>
<p>"Routine cycle service is recommended Please call your service provider."</p>	<p>Number of cycles, since last periodical maintenance, exceeded the "cycle service counter" parameter Or time elapsed exceeded the "time service counter" parameter.</p>
<p>"Power Down"</p>	<p>This message is displayed if power down has occurred during the cycle. (this message will print out in the printer after the autoclave will turn on).</p>
<p>Vacuum time error"</p>	<p>Vacuum pressure fails to reach the required value within the required time (in Vacuum test and Pre-vacuum stage)</p>
<p>Water fill Error</p>	<p>If DO10 is On for timer &gt; Parameter Water fill time out and DI2 (Max. float switch) is not On</p>
<p>Water tank filling, Please wait</p>	<p>If high water demand cycle is chosen (e.g. Prion) and Parameter&gt;0 (Auto fill) - Then before enabling Start message presented on GUI</p>

Message	Description
Please fill water tank to full for start	<p>For prion cycle in manual water filling configuration, when the water tank is not full the “Start” button will not appear, instead this error message will appear in the Active alarms screen.</p> <p>Prion cycle, in manual water filling and the water tank is not full</p>
Unrecognized printer	If printer is not recognized an error will appear in the UI.
Low Quality Water	<ol style="list-style-type: none"> <li>1. Read the water level from analog sensor.</li> <li>2. Translate the digital value to micro siemens according to the attached table.</li> <li>3. Compare the value system parameter (water quality reference, default 10).</li> <li>4. if value is less than 10 show error - Low Quality Water</li> </ol>
Set Atmosphere Pressure is Active	Present when Reset Atmospheric pressure is requested from Technician screen
“Not enough water detected”	If in the clean water tank, the Float switch does not change from 1 to 0 during water pump time On
Pipe water heater temperature time error	If the Pipe Water Heater works for more than 15 min.
Jacket water heater temperature time error	If the Jacket Water Heater works for more than 15 min.
“Analog Input Error - Jacket Temperature”	

Message	Description
Utility issue #1 – Please switch OFF and ON machine’s power switch	If windows card disconnects
Utility issue #2 – Please switch OFF and ON machine’s power switch	If WIN application crash/not start up
Utility issue #3 – Please switch OFF and ON machine’s power switch	If I/O card disconnected during power on
Time jumped during the cycle	If main system clock changed during the cycle
No-user log-in	If CFR-11 on and no user login

## 11. TSC Printer Installation (optional)

---

The following is a user's set up guide that explains describe:

- General printer information.
- Safety instructions
- How to install TSC printer and connect it to the T- Edge autoclave for the first time. (Shall be performed by qualified personnel).
- How to set, operate, use and maintain the printer after the first installation.

### 11.1 General printer information

The printer(s) are optional and can be purchased/ordered from Tuttnauer by the customer, the printers can easily be installed and connected to the autoclave following the instructions below.

The options includes:

- One printer connected to the autoclave, and can be loaded with thermal paper roll, or with label roll. The user can direct the printer to switch between printing on thermal paper roll or label roll.
- Two printers connected to the autoclave, one loaded with thermal paper roll, and the second printer is loaded with label roll.

#### 11.1.1 Printer Output:

The autoclave is equipped with a character printer, which prints a detailed history of each cycle performed. (This can be used for the record or for subsequent consideration.)

The printing is on thermal paper with a defined set of characters per line and contains important information such as some of the main following details:

- Date:, Time: , Ser. Num:., Model:., Version:.,
- Cycle Num:., Cycle Name:., Ster Temp:., Ster Time:., Dry Time:.,End Temperature

When the sterilization cycle begins the printer starts printing the above data.

After the preliminary printing, the autoclave starts performing the sequence of operations of the cycle. The measured values of temperature and pressure are printed at time intervals, according to the phase of the process, as shown in the table on the next page.

The data is printed from the bottom up, beginning with the date and ending with "Cycle Ended". For an aborted cycle, "Cycle Failed" and the Error message are printed (refer to "Displayed Error Messages/Symbols").

The printer can also print labels when loaded with label roll and printer1 is selected.

For an example of a typical printout, see next page.

IP: 192.168.137.1  
System vers.: 31007  
Cycle vers.: 421208  
I/O-card vers.: 1.1  
5001.2004.12.17  
SU vers.:  
Time: 07:23:01  
Date: 4/MAY/2020  
POWER ON  
Time: 13:05:45  
Date: 17/JAN/2019  
POWER OFF

-----  
Operator: \_\_\_\_\_  
Time: 15:00:00  
**Status: Test Ended**  
00:17:34 154.4 01.83In  
00:17:03 145.8 25.22In  
P3=25.219 (inHg)  
V 00:17:02 145.8 25.22In  
V 00:17:02 145.8 25.22In  
V 00:16:02 146.5 25.19In  
V 00:15:02 147.4 25.16In  
V 00:14:02 148.1 25.16In  
V 00:13:02 148.8 25.16In  
V 00:12:02 149.4 25.19In  
V 00:11:02 150.1 25.16In  
V 00:10:02 150.4 25.07In  
V 00:09:02 150.6 25.16In  
V 00:08:02 150.8 25.16In  
V 00:07:02 150.4 25.13In  
P2=25.130 (inHg)  
V 00:07:02 150.4 25.13In  
V 00:07:02 150.4 25.13In  
V 00:06:02 149.5 25.07In  
V 00:05:02 148.3 25.13In  
V 00:04:02 145.8 25.04In  
V 00:03:02 142.0 25.07In  
V 00:02:02 135.1 25.19In  
P1=25.130 (inHg)  
V 00:01:02 126.5 18.84In  
V 00:00:02 115.7 00.17  
Time °F psig  
End Temperature 230.0 °F  
Vac. Time2 10 min  
Vac. Time1 5 min  
Vac. Pres. 2.18 psia

**Vacuum Test**  
Cycle Num: 5  
5001.2004.12.17  
SU vers.:  
Version: 0  
Model: T-EDGE-10  
Ser. Num: 19060106  
Time: 14:50:34  
Date: 3/MAY/2020  
-----

## 11.2 Important safety instructions

1. Read all the instructions and keep them for future use.
2. Follow all warnings and instructions on the product.
3. Disconnect the power plug from the AC outlet before cleaning or if fault happened. Do not use liquids or aerosol cleaners. Using a damp cloth is suitable for cleaning.
4. The mains socket shall be installed near the equipment and easily accessible.
5. The unit must be protected against moisture.
6. Handle the equipment with care. Ensure the stability when installing the device, tipping or dropping could cause damage.
7. Make sure to follow the correct power rating and power type indicated on the marking label provided by the manufacturer.
8. Please refer instructions and to the user manual for maximum operation ambient temperature.



**Warning!**

**Hazardous moving parts, keep fingers and other body parts away.**



**Caution!**

**(For equipment with RTC (CR2032) battery or rechargeable battery pack)  
Risk of explosion if battery is replaced by incorrect type. Dispose of used batteries according to the instructions as below.**



**Caution!**

**The print head may be hot and could cause severe burns. Allow the print head to cool.**

**Please, refer to the printer manufacturer safety instructions**

### 11.3 Installation for the first time



#### Attention!

Due to the high temperature exuding from the autoclave's upper water tank, please refrain from locating the printer or other equipment on the top cover of the device.

#### Unpacking the printer:

1. Carefully open the printer box (1) and remove the printer packing.
2. Place the printer (2) on the table, and remove the two tapes (3).
3. Remove the rest of the box content which includes USB communication cable (6), electrical power cable (7), CD (5), adapter (8), blue cable (9), and the printer instructions (4).

**Note:** the USB communication cable or other cables may come in another additional box.

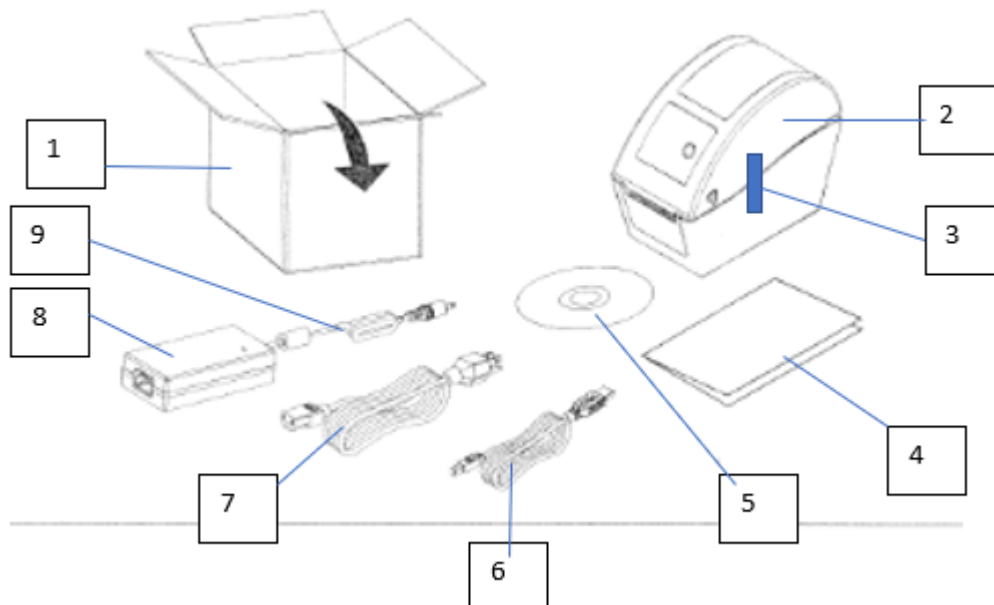



## 11.4 Open the printer top cover

1. Remove the two tapes bonding the printer body to its cover (1) on each opposite sides of the printer.
2. Pull the two handles left and right (2) simultaneously together forward as shown by the arrows in figure 1.
3. The top printer cover will lift as shown in the figure indicated by 2.

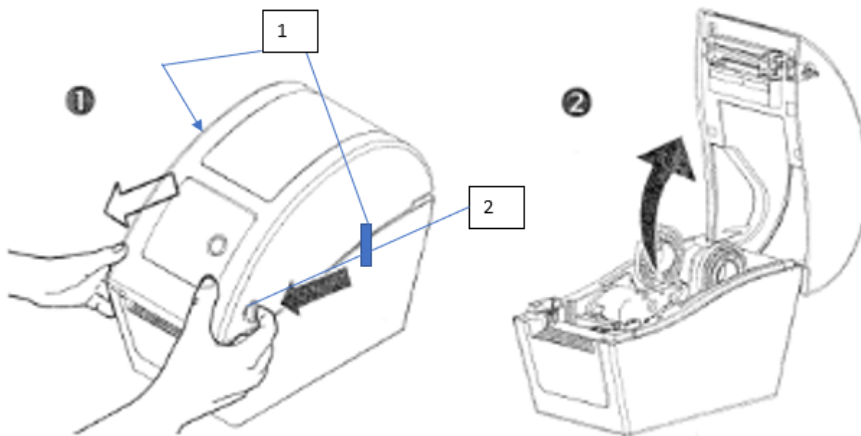

## 11.5 Loading thermal printer paper roll/ Label roll

You can either load a thermal paper roll, or label roll on the printer roll compartment opening.

You can also connect two printers to the autoclave, one loaded with thermal paper roll, and the second printer loaded with label roll.

1. Slide switch (item 1) forward shown in fig 2, it will allow to move the roll holders (2) apart as shown in fig 1 below, allowing to put the paper roll on the holders.
2. Adjust the roll holder (2) as shown in (item 3) in figure 3 depending if a thermal or label roll is installed.
3. Place the thermal paper roll or label paper roll as shown in (item 4) figure 3.or,
4. Place the label roll as shown in (item 5) figure 4.

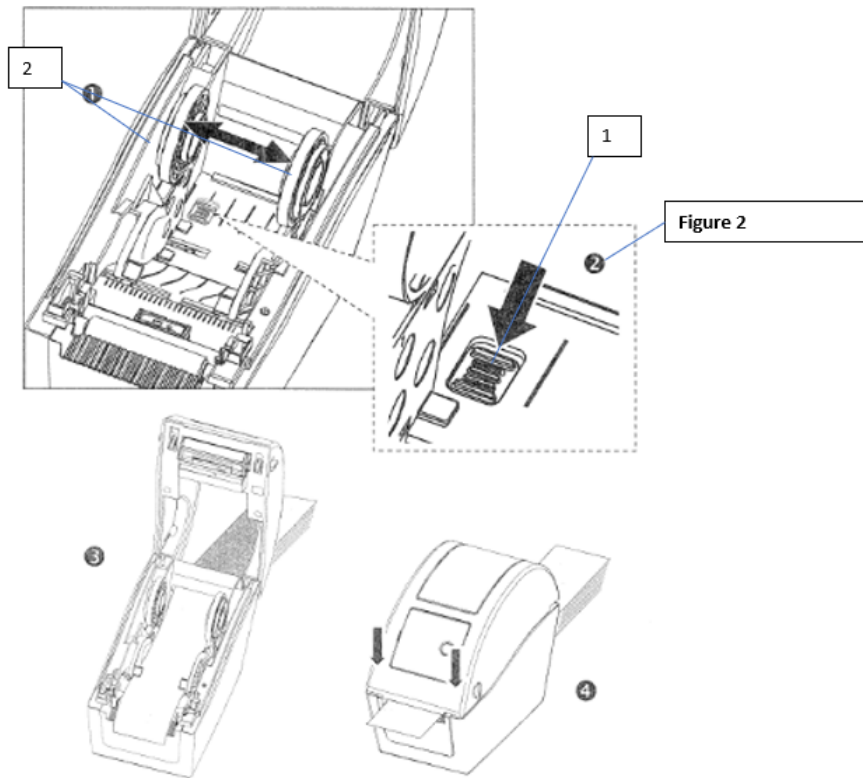

5. Insert the paper under the two paper guides (item 6) in figure 3 for the paper roll, pull the paper to extend it beyond the printer. Do the same for the label roll (item 6) figure 4.

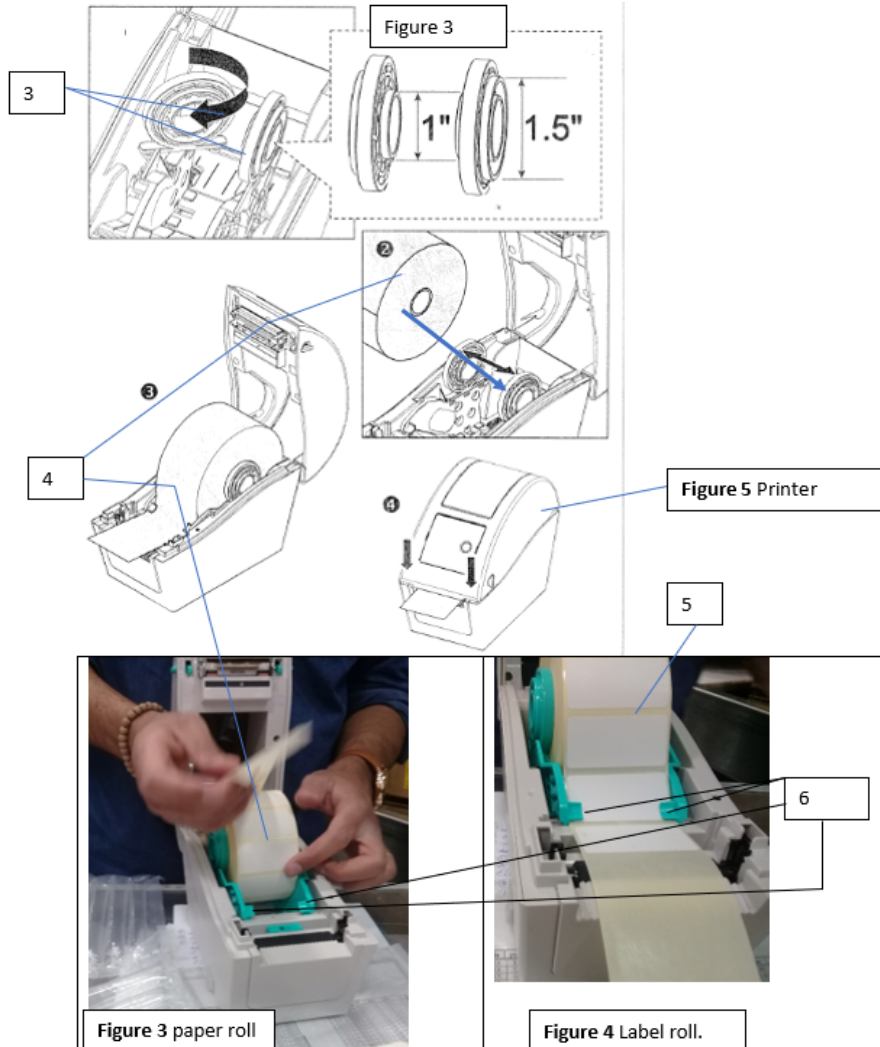

6. Push the printer cover down (fig 5) until you can hear a click indicating that the cover is connected to the printer bottom.

## 11.6 Connecting the interface cables to the printer

1. Connect the adapter male (1) to the RC-232 Output Port blue cable female plug connection (2), tighten and secure the 2 screws (3) to the adapter.
2. Plug the adapter connected with the blue cable (8) to the printer adapter connection, Tighten the 2 screws (4). To the printer (5) using screwdriver shown below.
3. Connect the Power cable (6) to the printer back port.

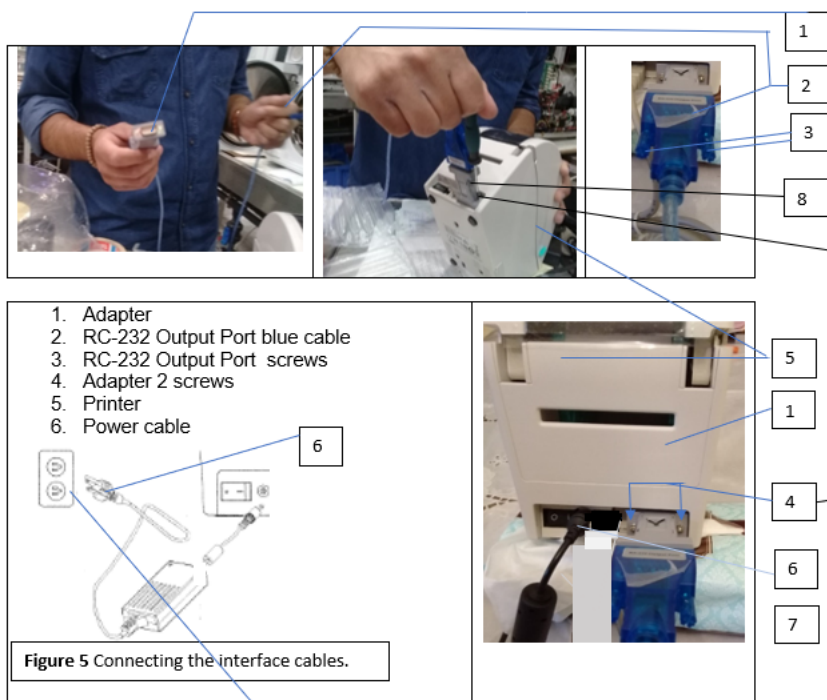

4. Connect the power cable connector of cable (6) coming from the printer to the electrical power source on the wall.

## 11.7 Connecting power and interface cables

1. Connect the RC-232 Output Port blue cable (6) to the back of the autoclave (4).
2. Connect the power cable plug connector of cable (6) coming from the printer to the electrical power source on the wall.



3. Turn on the printer power

## 11.8 Starting the printer

1. Press on the button in the front of the printer cover, keep pressing the finger while switching on the printer power at (1) the printer back. (Step 1 and 2 shall be done simultaneously).

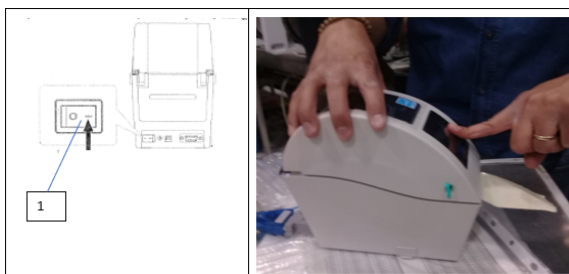

2. Switch on the printer power (1) at the printer back, keep pressing the finger in step 1 until the red light bulb in front start flashing.



3. Ensure that the green bulb lights.

The printer will run and feed the roll until the end of calibration process, approximately half meter for paper roll, and 3 labels for label roll.

## 11.9 Setting Printer definitions

The following are the login procedures for new user:

1. Press on the quick options menu



2. Press on  icon.
3. Enter administration password Select from drop down list.
4. Press Login Enter administration password Select from drop down list

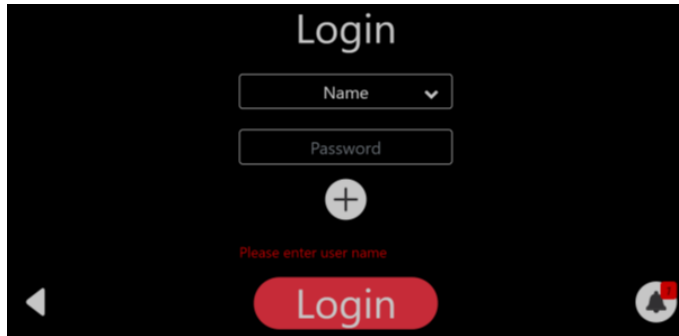

5. Press on the quick option 

6. Press on new 

7. Press on system parameters

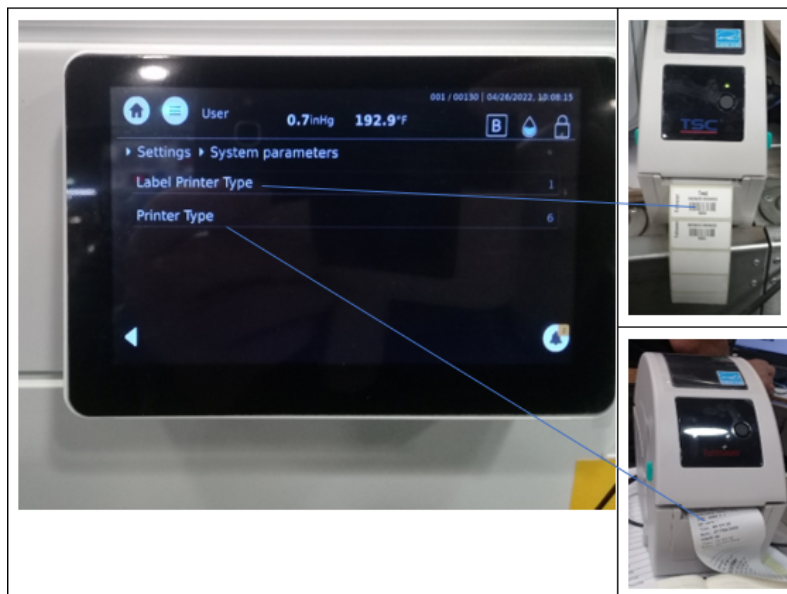

8. Select for paper roll printer type 6. Select for label roll label 1.

9. If only the one printer is connected to the autoclave, local=0 or printer=1.

The following table gives the various printer possibilities

<b>Printer Type</b>	<b>Local</b>
Only paper roll 6	0
Only Label roll 1	1
Both paper roll and label roll are connected 6	1



## 12. Chamber Clean Program

### 12.1 General

The Chamber Clean program is a cleaning and descaling process for the family of Tuttnauer's T-Edge Autoclaves. It uses one tablet from the package - Cat.#: CLE 096-0070/71/72.

The tablet is composed from chemicals that are specifically designed for cleansing and removal of water deposit oxides and other sediments that exist in the Chamber of steam sterilizers.

**Perform chamber clean every week.**

Chamber Clean Program-Icon Picture

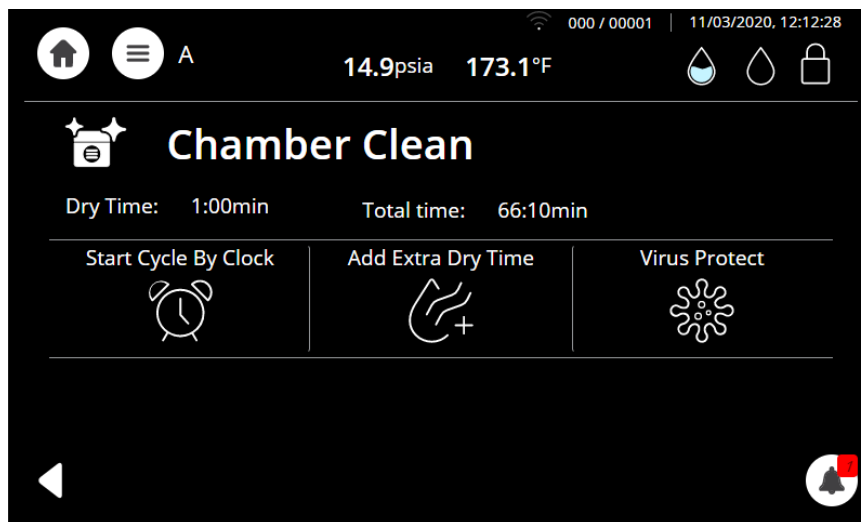

## 12.2 Chamber Clean cleaning procedure

The Chamber Clean cleaning program for the family of Tuttnauer's T-Edge Autoclaves is described below:

**Important :**

**To avoid burns when removing the trays and holders, the Chamber must be cold.**

1. All steps in this procedure must be completed without interruption.
2. Open the autoclave chamber door.
3. Remove instruments and any load, trays from the autoclave chamber.
4. Place the trays and tray holder in the sink to be cleaned with a stainless steel Safe cleaner.
5. Place one tablet (1) from the tablet packing (2) inside the sterilization chamber at the back bottom of the cold chamber.(see figure below).

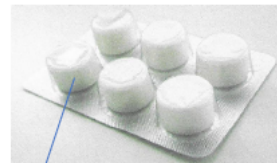
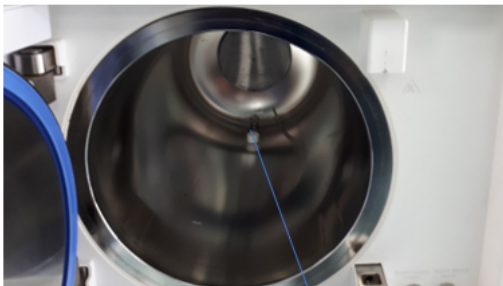

1. Tablet
2. Tablet from packing

6. Close the autoclave door.
7. Fill the clean water reservoir with **distilled water only**. (Either Automatic or Manual filling) until the screen indicates full.

8. Chamber Clean program-Manual fill clean water tank.

To fill water in the reservoir, lift the water reservoir cover and fill with clean water (see below).

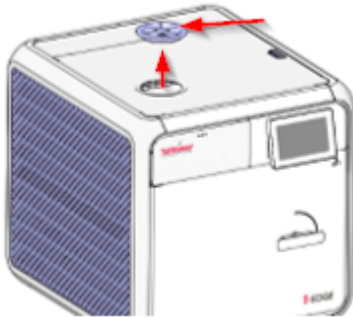

9. Chamber Clean program-Water tank clean & waste

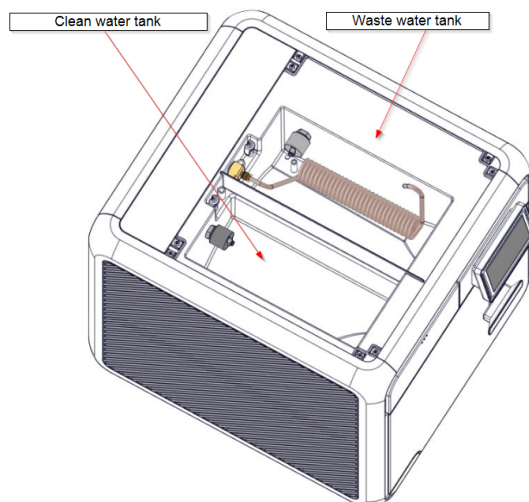

10. Select Chamber Clean program

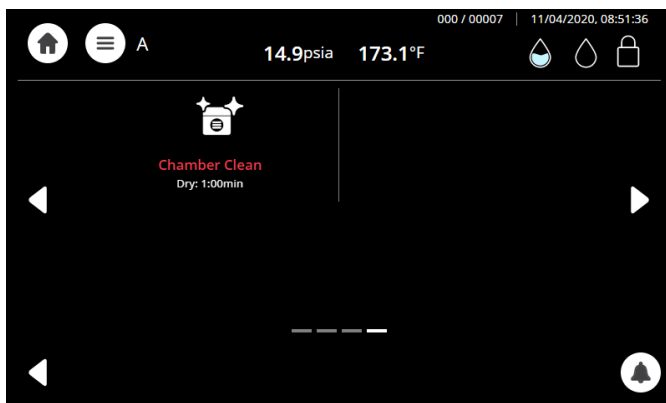

11. Chamber Clean program -Start Cycle

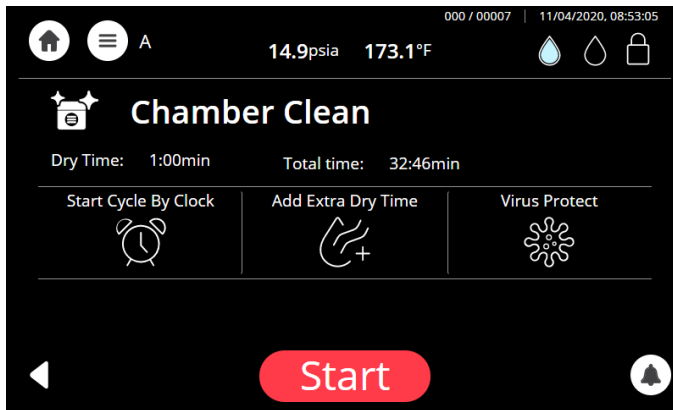

12. Chamber Clean program-Water tank alarm

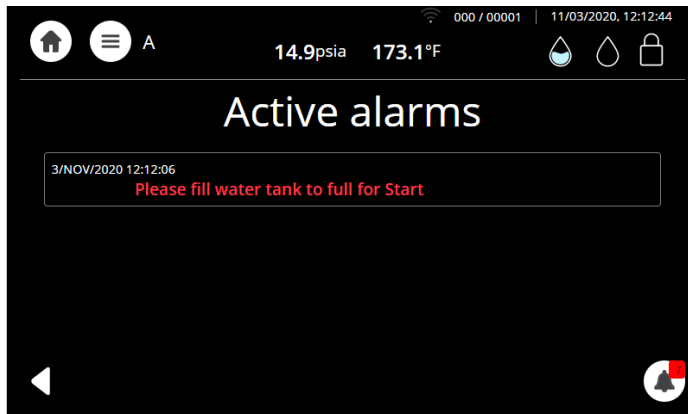

13. Chamber Clean program set to the manual filling mode of the clean water tank

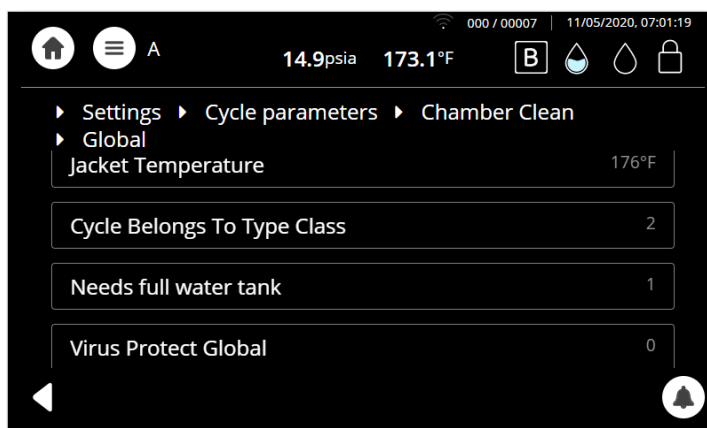

14. An alarm will appear while water tank is filling.

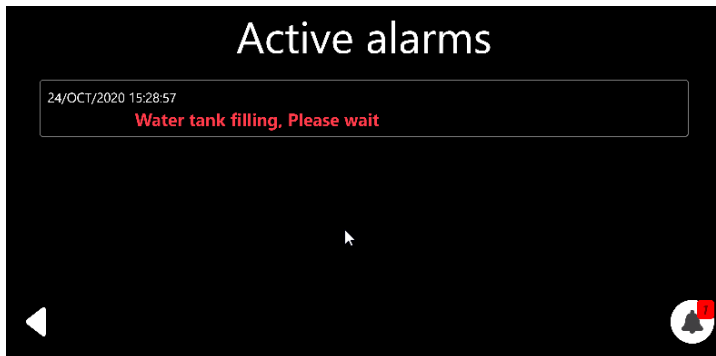

15. Chamber Clean program - Cleaning-insert- Water stage.  
The process lasts approx. one hour.



16. Chamber Clean program - Cleaning-Keep stage.



17. After approx. 60 minutes the Chamber Clean process is completed. The Chamber is clean, and the following screen is displayed.

Chamber Clean program-cycle confirm by operator.

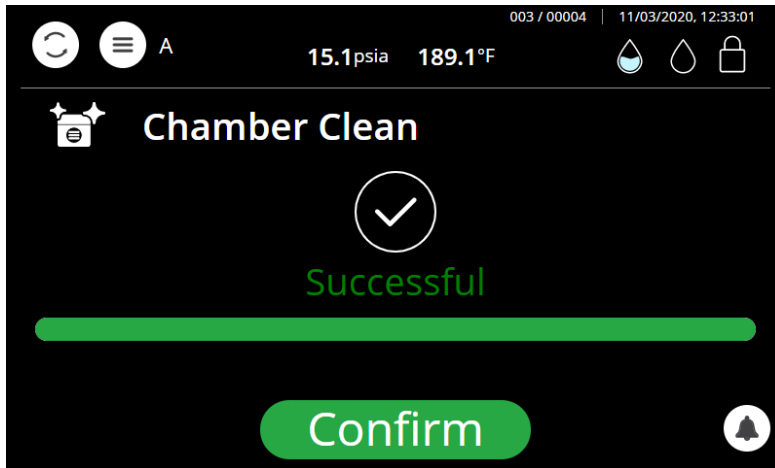

18. Wipe clean leftover residue.

## 13. Factory Codes for end user

---

**Notice: Please, find below Factory Codes for end user.**

**These codes are similar to all T-Edge machines from version 1.0.**

Level 1 Factory Code 010	7N613IOJT6	Admin - for User Manual
Level 1 Factory Code 011	4YFBH5G597	Admin - for User Manual
Level 1 Factory Code 012	KX4D3O2IZ0	Admin - for User Manual
Level 1 Factory Code 013	E6QS7RCBF4	Admin - for User Manual
Level 1 Factory Code 014	UC3VUOCEGD	Admin - for User Manual
Level 1 Factory Code 015	KQTPXJT37P	Admin - for User Manual
Level 1 Factory Code 016	PGU318IXEZ	Admin - for User Manual
Level 1 Factory Code 017	3F0ENI3ISP	Admin - for User Manual
Level 1 Factory Code 018	LYBVQXMB4X	Admin - for User Manual
Level 1 Factory Code 019	8JDZPNRA4W	Admin - for User Manual
Level 1 Factory Code 020	GPAQKFZPCO	Admin - for User Manual
Level 1 Factory Code 021	PKKSD0F9MD	Admin - for User Manual
Level 1 Factory Code 022	WG2Q1UBBY9	Admin - for User Manual
Level 1 Factory Code 023	03O6I6YUKL	Admin - for User Manual
Level 1 Factory Code 024	868PHX8VVZ	Admin - for User Manual
Level 1 Factory Code 025	ISX099WTZ0	Admin - for User Manual
Level 1 Factory Code 026	DY0CYW6OJH	Admin - for User Manual
Level 1 Factory Code 027	BUYBFZIMJE	Admin - for User Manual
Level 1 Factory Code 028	VQP91IFY6J	Admin - for User Manual
Level 1 Factory Code 029	JF5THJF61U	Admin - for User Manual
Level 1 Factory Code 030	1ULOXX3VUJ	Admin - for User Manual
Level 1 Factory Code 031	1KKUEWI1LP	Admin - for User Manual
Level 1 Factory Code 032	QHR976ZE46	Admin - for User Manual
Level 1 Factory Code 033	TMUYMBFBLE	Admin - for User Manual
Level 1 Factory Code 034	OTEWS95KOU	Admin - for User Manual
Level 1 Factory Code 035	AOUMETCLQ1	Admin - for User Manual
Level 1 Factory Code 036	7Z1X0PZVHD	Admin - for User Manual

Level 1 Factory Code 037	RGQHB6D4R7	Admin - for User Manual
Level 1 Factory Code 038	APZJ5F1IT3	Admin - for User Manual
Level 1 Factory Code 039	93VTGY2Q6C	Admin - for User Manual
Level 1 Factory Code 040	KJCLC48NKH	Admin - for User Manual
Level 1 Factory Code 041	QI3S1S9S2U	Admin - for User Manual
Level 1 Factory Code 042	XRCOEYV6AM	Admin - for User Manual
Level 1 Factory Code 043	EW7PX1MNGB	Admin - for User Manual
Level 1 Factory Code 044	HO7MM19C2Y	Admin - for User Manual
Level 1 Factory Code 045	ZKYMO2HXHO	Admin - for User Manual
Level 1 Factory Code 046	IBM8C3KO49	Admin - for User Manual
Level 1 Factory Code 047	FWL0NJTZCN	Admin - for User Manual
Level 1 Factory Code 048	YSEM48VA4	Admin - for User Manual
Level 1 Factory Code 049	TYG12FB9JT	Admin - for User Manual
Level 1 Factory Code 050	QVH2SC878F	Admin - for User Manual



Cat. No. MAN205-0502003EN Rev. C  
COPYRIGHT ©