

**THERMODISINFECTOR
TIVA2 TD
TIVA2-H TD**



INSTRUCTIONS FOR USE



Before starting to operate with the thermodisinfectors, read these instructions for use

Translation of the original instructions
code MAN205-0717001EN - Rev. 00
Edit. 06-2020
Language: English

TRANSCRIBE THE MACHINE DATA

MODEL: _____

SERIAL NUMBER: _____

YEAR OF MANUFACTURE: _____

THIS DATA MUST ALWAYS BE QUOTED WHEN REQUESTING ASSISTANCE AND/OR SPARE PARTS TO THE MANUFACTURER.

MANUFACTURER:

TUTTNAUER LTD. HAR-TUV B INDUSTRIAL ZONE

P.O BOX 170 BEIT SHEMESH 9910101, ISRAEL

TEL. 972 2 9904611 - FAX. 972 2 9904700

US OFFICE: TUTTNAUER USA Co.LTD.

25 POWER DRIVE HAUPPAUGE, N.Y. 11788, USA

TEL: +1 631 737 48 50 - TEL: +1 800 624 58 36 - FAX: +1 631 737 07 20

WWW.TUTTNAUERUSA.COM

MODELS COVERED BY THE MANUAL:

CT = TIVA2 TD

UC = TIVA2-H TD

WARNING

IT IS STRICTLY FORBIDDEN TO USE THE MACHINE BEFORE HAVING READ AND UNDERSTOOD THIS MANUAL.

THE MANUFACTURER DECLINES ALL AND ANY LIABILITY FOR DAMAGE DUE TO NEGLIGENCE AND FAILURE TO COMPLY WITH THIS MANUAL AND IS ALSO NOT LIABLE FOR ANY DAMAGE CAUSED BY INCORRECT INTERPRETATIONS OF THE INSTRUCTIONS CONTAINED.

CHECK FOR ANY UPDATES TO THIS MANUAL ON THE MANUFACTURER'S WEBSITE.

CONTENT

1 SYMBOLS USED IN THE MANUAL	4
2 PRESENTATION	4
2.1 FIELD OF APPLICATION	5
2.2 WARRANTY	5
2.3 WARRANTY EXCLUSIONS	5
2.4 PRODUCT ANALYSIS	6
2.4.1 INLET WATER QUALITY	7
2.5 TECHNICAL DATA	7
2.6 ACCESSORIES	8
3 SAFETY AND PREVENTION	10
3.1 GENERAL WARNINGS	10
3.1.1 USER OBLIGATIONS	10
3.1.2 INSTALLER OBLIGATIONS	10
3.1.3 OPERATOR OBLIGATIONS	10
3.1.4 MAINTENANCE TECHNICIAN OBLIGATIONS	11
4 HANDLING	11
4.1 STORAGE	13
5 INSTALLATION	13
5.1 BUILT-IN INSTALLATION	14
5.2 STAND-ALONE INSTALLATION	14
5.3 ELECTRICAL CONNECTION	14
5.3.1 ELECTRICAL CONNECTION	14
5.4 WATER CONNECTION	15
5.4.1 CONNECTION TO THE WATER DRAIN	17
5.5 FILTERS, SPRAY ARMS AND REGENERATION SALT	17
5.5.1 FILTERS	17
5.5.2 SPRAY ARMS	17
5.5.3 REGENERATION SALT	18
5.5.4 SALT REFILL	18
5.5.5 AUTOMATIC REGENERATION	18
5.6 CHEMICALS	18
5.6.1 REFILL PROCEDURE	19
5.6.2 USING AND STORING CHEMICALS	19
6 USING THE MACHINE	20
6.1 COMMISSIONING INSTRUCTIONS	20
6.1.1 LOADING THE CHEMICALS	21
6.2 BEFORE USE	22
6.2.1 EMERGENCY RELEASE	22
6.2.2 PREPARING THE LOAD	22
6.2.3 BORER CHEMICALS	22
6.2.4 SUMMARY OF THE BASKET LOADING OPERATIONS	23
6.2.5 TREATMENT OF DENTAL INSTRUMENTS	24
6.2.6 TREATMENT OF OPHTHALMIC INSTRUMENTS	24
6.3 PROGRAMS	24
6.4 STARTING THE MACHINE	25
6.4.1 BEFORE STARTING THE PROGRAM	25
6.4.2 STARTING THE PROGRAM	25
6.4.3 PROGRAM END	26
6.4.4 EXTRACTING THE LOAD	26
6.5 CONTROL PANEL	27
6.5.1 COLORS OF THE KEYS	27
6.6 DISPLAY	28
6.6.1 MESSAGES ON THE DISPLAY	28
6.6.2 DISPLAY SCREENS	29
6.6.3 PROGRAM 2 STANDARD	30
6.6.4 ALARM MESSAGES	33
6.6.5 USER SETTINGS MENU	33
6.6.6 SETTINGS	34
6.6.7 LANGUAGE SETUP	34
6.6.8 USB STICK MANAGEMENT	34
6.6.9 PROCEDURE FOR PASSWORD CHANGE	35
6.6.10 EXPIRING PASSWORDS	35
6.7 ALARMS	35
6.8 WARNINGS	35
7 SOFTWARE DESKTOP	35
7.1 GENERAL INFORMATIONS	35
7.2 FIRST ACCESS LOGIN	35
7.3 FIRST LOGIN	35
7.3.1 PASSWORD CHANGE	35
7.4 CABLE CONNECTION TO THE DEVICE	36
7.5 WORKING FOLDER SETUP	36
7.6 DATA IMPORT	36
7.7 DATA VISUALIZATION	36
7.7.1 ADMIN AVAILABLE FEATURES	36
7.7.2 USER AVAILABLE FEATURES	37
7.7.3 REPORT VISUALIZATION	37
7.8 PASSWORD RESET	38
7.8.1 USER LOGIN DATA LOST	38
7.8.2 ADMIN LOGIN DATA LOST	38
8 MAINTENANCE	38
8.1 GENERAL INFORMATION	38
8.1.1 ROUTINE MAINTENANCE	38
8.1.2 SPECIAL MAINTENANCE	39
8.1.3 AIR SUCTION FILTER	39
8.2 TROUBLESHOOTING	40
8.3 EQUIPMENT DISPOSAL	40
8.4 SPARE PARTS	40
9 ANNEXES	40
9.1 INSTALLATION SCHEME FOR CT	42
9.2 INSTALLATION SCHEME FOR UC	43
9.3 PROGRAMS DETAILS	44
9.4 MENU PARAMETER TABLE	45
9.5 MENU STRUCTURE	46
9.6 PROCEDURE FOR PASSWORD CHANGE	47
9.7 PROCEDURE FOR USER PASSWORD SETUP FOR THE SUPER USER	48
9.8 PROCEDURE FOR SUPER USER PASSWORD CHANGE	49
9.9 ALARM TABLE	50
9.10 WARNINGS TABLE	51
9.11 TROUBLESHOOTING	52
9.12 SPARE PARTS	52
9.13 FUSES	54

1 SYMBOLS USED IN THE MANUAL

Actions of particular importance or of potential risk and danger are highlighted in the manual with a symbol whose meaning is set out below.



CAUTION! This sign warns that if the operations described are not correctly performed, they can damage the machine.



WARNING! This sign warns that if the operations described are not correctly performed, they can cause serious injury, death or long-term health risks.



HAZARD! This sign warns that if the operations described are not correctly performed, they cause serious injury, death or long-term health risks.



HAZARD! This sign indicates hot surfaces. Danger of burns.



HAZARD! This sign indicates a potential risk of electric shock that can cause serious injury, death or long-term health risks.



IMPORTANT NOTE! Carefully read and memorise the information.

2 PRESENTATION

This use and maintenance manual is specific for the use of the thermoisinfector, hereinafter also called machine, manufacturer data available on the cover.

This manual is an integral part of the thermoisinfector itself, which must be kept in a safe place and known to the personnel in charge and must always accompany it when moved or resold.

The personnel in charge must be suitable and able to read and understand the contents of this manual. Furthermore, the personnel in charge must use the thermoisinfector bearing in mind the accident-prevention regulations in force, the conditions of use and the thermoisinfector features.

The same personnel must store it and keep it intact to allow its consultation throughout the life-span of the machine itself.

The personnel in charge must strictly and diligently follow the instructions, warnings and all indications contained in this manual.

The contents relate to normal use and maintenance operations. The manual does not include instructions for special interventions that are outside the routine use of the thermoisinfector.

The removal and/or tampering with the safety devices and protections, fitted on the thermoisinfector, will automatically void the warranty and liability of the manufacturer.



WARNING: The manufacturer also declines any and all liability for failure to comply with the safety and prevention regulations provided by the legislation and the provisions of this manual.

If the manual is damaged or lost, a copy must be immediately requested from the manufacturer.



WARNING: The machine must only be installed and dismantled by personnel trained for the purpose.

There are two models of disinfectant discussed in this manual: the countertop "CT" and under-the-counter "UC" models, which substantially differ externally in dimensions. See the installation scheme: Annex A. The CT model is the classic model of thermoisinfector with small-sized product bowls, which can be positioned on any piece of furniture capable of withstanding its weight, within a dental practice.

The UC model is a thermoisinfector with much more capable product bowls than the countertop version and which, usually, is embedded under a piece of furniture where appropriate space is already provided, within a dental practice.



WARNING: Failure to comply with the instructions in manual, operational negligence, incorrect use of the thermoisinfector and execution of unauthorised changes, both on the machine and on the programs, are the cause of cancellation by the manufacturer of the warranty granted.

2.1 FIELD OF APPLICATION

This machine, intended for washing and disinfecting, is considered a class IIb medical device (as defined by Directive 93/42/EEC class IIb). With this machine, also called thermoisinfector, it is possible to treat medical devices, e.g. dental instruments, saliva ejectors, standards, etc., whose manufacturers expressly state that they can be treated in the machine. Follow the instructions of the instrument manufacturers (according to EN ISO 17664), as well as the national laws and directives for the automatic treatment of medical devices. The personnel in charge using the machine daily must be aware of its main features, and must also receive adequate and continuous training. Each thermoisinfector is equipped with identification plates bearing (for the position, see figure 3a and 3b):

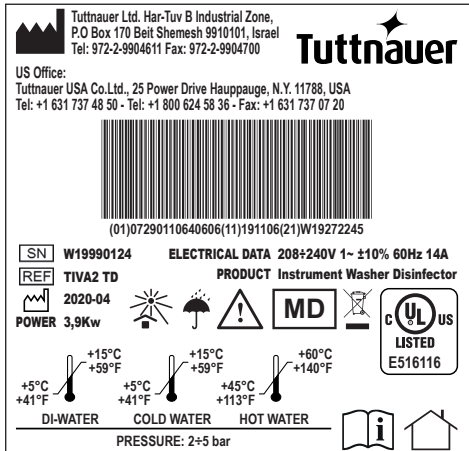

Fig. 2

Above an example of the device label.

2.2 WARRANTY

The manufacturer warrants its newly manufactured products for 12 (twelve) months from commissioning from the date of delivery of the thermoisinfector provided that in the meantime it has not undergone changes and interventions of any kind by the user. Within the aforementioned terms, the manufacturer undertakes to supply free of charge the spare parts of those parts which, at its sole discretion, or of its authorised representative, show manufacturing defects, or at its discretion, carries out repairs directly or through authorised personnel. In any case, labour costs for replacing defective parts are always charged to the Customer.

- The right to warranty services is only recognised if, once the defect is found, it is immediately reported to the manufacturer, at the same time sending the related repair request.
- Without prejudice to the Customer's right to warranty service in the above terms, it is expressly excluded that the Customer may request termination of the contract, replacement of the thermoisinfector or reduction of the sale price, as well as compensation for any direct or indirect damage.
- The manufacturer grants the warranty at its discretion, according to the technical needs, to repair or replacement of the defective parts.
- The replacement or repair of parts under warranty will not, in any case, extend the warranty terms.
- The expenses due to routine and special maintenance interventions on the thermoisinfector are, in any case, the purchaser's responsibility.
- Transport costs, VAT and any custom duties are the purchaser's responsibility.



The purchaser will only be able to enforce its warranty rights if it has complied with any additional conditions concerning the warranty service, also indicated in the supply contract.

2.3 WARRANTY EXCLUSIONS

The warranty lapses (in addition to what is stated in the supply contract):

- When the purchaser has not complied with the contract payment obligations.
- When the purchaser has not reported the vices to the seller within eight days of delivery, in writing and commissioning the execution of the related intervention.
- If the thermoisinfector or parts thereof have been used differently from their intended use.
- If the thermoisinfector has been previously entrusted for repair to personnel not authorised by the manufacturer.
- If an operating error attributable to the operator occurs.
- If the damage is due to insufficient maintenance.
- If parts have been assembled on the thermoisinfector, the use of which has not been authorised by the manufacturer.
- If the instructions regarding use, maintenance and assistance of the thermoisinfector, contained in this use and maintenance manual, have not been complied with.

- If chemicals not identified by the manufacturer as compatible with the thermodisinfectors are used.

Damage deriving from negligence, carelessness, misuse and improper use of the machine is also excluded from the warranty.

For complex repairs or revisions, please contact specialised and authorised personnel or the Manufacturer directly, which is available to ensure prompt and accurate technical assistance and everything necessary for restoring the full efficiency of the thermodisinfectors.

If the parties do not intend to submit to arbitration any disputes arising from the supply contract or in any other case in which the judgement of a judicial body is required, only the nearest Court to the manufacturer headquarters shall have jurisdiction.



This manual is the basic tool for personnel who, in various capacities, take care of the machine.

- **USER:** The user is the person, body or company that has purchased or rented the machine and intends to use it for the intended purposes. It is the authority appointed personally for training the personnel in charge of using and maintaining the machine. Must also make sure that the personnel in charge have acquired all the information necessary for the use and routine maintenance of the machine.
- **SUPER USER:** Is the user that has special accesses to the device's menu for extra settings.
- **INSTALLATION OPERATOR:** The person(s) in charge of installing, operating, adjusting, maintaining, cleaning, repairing and transporting the machine. Can perform every operation concerning machine positioning at the User's premises, the connection of different systems, machine commissioning as well as routine and special maintenance. He/she is also able to proceed with the final demolition of the machine.
- **RUNNING OPERATOR:** The machine operator must be perfectly familiar with all of its command and control devices. The operator in charge of the machine must also be able to perform these actions:
 - Machine commissioning and operation;
 - Loading and unloading of the material being washed on the baskets;
 - Using the machine in all the different operating modes, such as the start-up of the different washing cycles provided;
 - Reset any alarms triggered;
 - Using all personal protection equipment, and complying with all adequate safety procedures,

he/she should be able to carry out some routine maintenance operations, such as cleaning the clogged filters on the tank bottom and filling the machine with cleaning liquids and chemical additives.

- **SPECIALISED PERSONNEL:** People specially trained and authorised to perform repairs or maintenance that require special knowledge of the machine and are able to recognise the dangers deriving from incorrect or improper use of the machine itself.

Before proceeding with the various operations, the above listed operators, must have carefully read and memorised this manual.

The thermodisinfectors packaging, in addition to the use and maintenance manual, contains the two spray arms that will be applied on the tank, the flexible hoses for the hydraulic connections and the drain pipe supply wire.

Upon delivery, check that the thermodisinfectors is intact and that the above-described material is actually present.

The installation, wiring and hydraulic diagrams (water filling and draining) can be downloaded from the manufacturer's website.

2.4 PRODUCT ANALYSIS

The disinfectors were tested by applying «UL 61010-1 CAN/CSA-C22.2 61010-1-12 IEC 61010-2-010 61010-2-040 Safety requirements for electrical equipment for measurement, control, and laboratory use Part 2-040 Particular requirements for sterilizers and washer-disinfectors used to treat medical materials», where the thermodisinfectors is expected to:

- be used exclusively for internal uses;
- be operational up to a maximum altitude of 2000 metres;
- be operational at a temperature between 5 and 40°C;
- operate in an environment with a maximum humidity of 80% for temperatures up to 31°C, decreasing linearly to 50% at 40°C;
- with a mains voltage fluctuation up to $\pm 10\%$ compared to the nominal voltage;
- temporary type overvoltages:
 - of short duration, which may occur between the line conductor and the system earthing, which may have a voltage equal to the power supply voltage on the line-neutral +1200V, and a duration up to 5s;
 - of long duration which may occur between the line conductor and the system earthing, which may have a voltage equal to the power supply voltage on the line-neutral +250V, and a duration greater than 5s;
- pollution degree 2.
- The validation of the product was made by the manufacturer in compliance with standard ISO

15883; the validation of the disinfection process is borne by the user.

- The machine does not cause harmful vibrations.
- The residual radiation emitted within the limits is non-ionising.
- The useful life cycle of the device is 10 years.
- The machine must not be dumped when scrapped, as it contains materials subject to legislation requiring disposal at special centres.

2.4.1 INLET WATER QUALITY

The quality of the water used in all stages of cleaning is important for good results.

The water used in each stage must be compatible with:

- The material which the washer disinfectant is made of.
- The chemicals used in the process.
- Process requirements for the various stages of the process.

The main factors for good inlet water quality in relation to the effectiveness of washing are:

HARDNESS

The high hardness of the water generates a detergent inactivation, reducing its efficacy. It also causes limescale deposits in the machine, jeopardising the cleanliness of the instruments and the machine, especially on hot parts (ex. heating elements).

IONIC CONTAMINANTS

A high concentration of ionic contaminants may cause corrosion of steel, manganese or copper instruments.

MICROBIAL CONTAMINANTS

Microbial contaminants can increase the microbial contamination of the instruments at the end of the wash.

The manufacturer therefore recommends that:

- the water used in the pre-rinse and washing stage should be of drinking quality according to the "Guidelines for drinking-water quality, 3rd edition" published by the WHO.
- demi water is used for the rinsing and disinfection. A typical specification for demi water is:

Ion concentration H ⁺	4.5...7 pH
Conductivity	< 30 $\mu\text{s}\cdot\text{cm}^{-1}$
TDS	< 40 mg/l
Maximum hardness (CaCO ₃)	< 10 mg/l
Chlorine	< 10 mg/l
Heavy metals	< 10 mg/l
Phosphates	< 0.2 mg/l as P ₂ O ₅
Silicates	< 0.2 mg/l as SiO ₂
Endotoxins	< 0.25 EU/ml
Colony-forming units (CFU)	< 100 for 100 ml (*)

(*) for rinsing after disinfection phase, the maximum limit changes to 0.

Further advice should also be obtained from the manufacturers of chemical and medical equipment. Where local standards are stricter than the provided recommendations, they should be followed.



Note: it is the user's responsibility to supply the machine with suitable water.

2.5 TECHNICAL DATA

Description	CT	UC
Width	23,4" (595 mm)	23,4" (595 mm)
Depth with door closed	21,3" (540 mm)	21,3" (540 mm)
Height	23,6" (600 mm)	32,2" (818 mm)
Total weight	143,3 lbs. (65 kg)	176,3 lbs. (80 kg)

WASHING TANK DIMENSIONS:

Width	16,3" (415 mm)	16,3" (415 mm)
Depth	18,9" (480 mm)	18,9" (480 mm)
Height	14,8" (375 mm)	14,8" (375 mm)
Protection absorbed power voltage	See data plate and installation diagram	
Average sound level degree	<70 dB (A)	
Type of protection (according to IEC 60529)	IP 20	
Marking	Directive on medical devices 93/42/EEC, class IIb	

Residual water volume in the chamber

- Condenser: 0 US gal (0 l)
- Standard configuration (without water softener): 0,11 US gal (0.4 l)
- Configuration with water softener (resins and salts): 0,37 US gal (1.4 l)

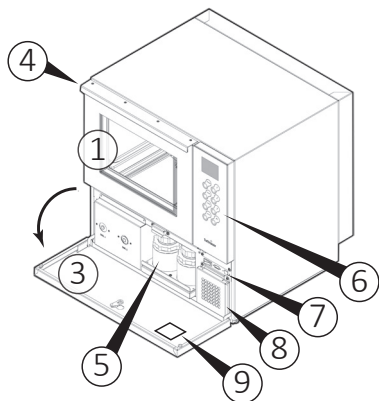
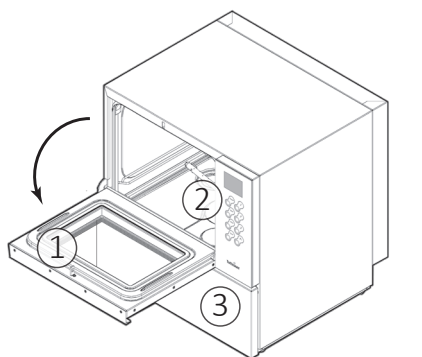

Fig. 3a - Main components of the CT model

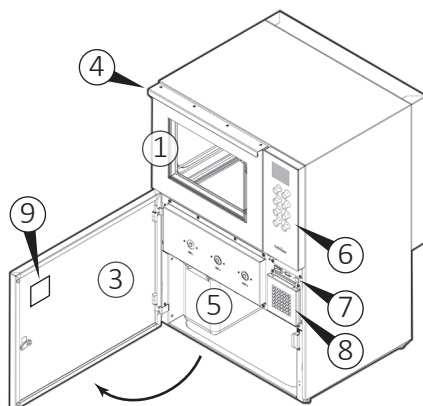
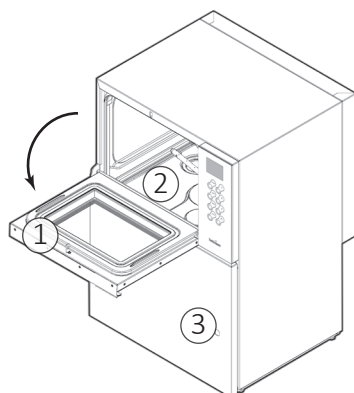

Fig. 3b - Main components of the UC model

- 1) Upper door with tempered glass, or Stainless Steel in the corresponding version (maximum load with door open 12 kg).
- 2) Internal tank.
- 3) Lower drawer door with lock.
- 4) Upper door opening handle.
- 5) Detergent containers for washing and rinse aid/neutralising product.
- 6) Control panel.
- 7) ON/OFF switch (machine on / off).
- 8) Air suction filter. Not present in the version without drying.
- 9) Label identification and position.

2.6 ACCESSORIES

The machine leaves the factory without any accessory/basket. The user must request the most suitable accessory/basket from the manufacturer. Figure 4 shows some examples of the most common use accessories.



Fig. 4a

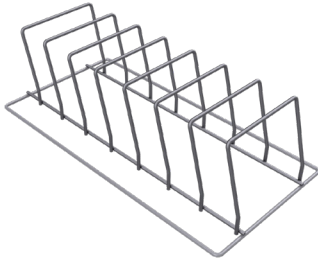

Fig. 4b

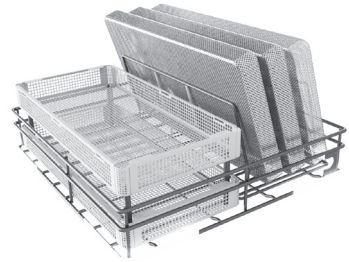

Fig. 4f

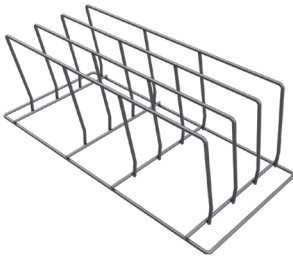

Fig. 4c

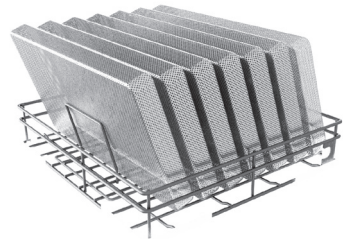

Fig. 4g

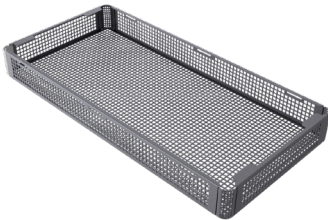

Fig. 4d

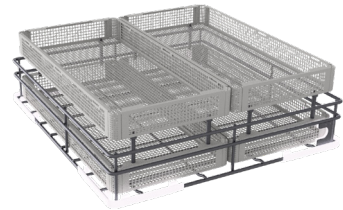

Fig. 4h



Fig. 4e



Fig. 4i

- 4a: Standard basket with tub cap.
- 4b: Insert tray basket for 8 trays.
- 4c: Insert instruments cassette for 3 cassettes.
- 4d: Basket for small bits and objects.
- 4e: Basket spacers.
- 4f: Basket configuration.
- 4g: Basket configuration.
- 4h / 4i: Basket configuration examples.

3 SAFETY AND PREVENTION

The operator in charge must be instructed on the risks deriving from accidents, on the devices prepared for the safety of the operator and on the accident-prevention rules provided by the legislation of the country of use of the machine. When realising the machine, all potentially dangerous situations have been foreseen and appropriate protections have been adopted. However, the level of accidents caused by careless and awkward use of the machine remains high. Distraction, carelessness and too much confidence are often cause of injuries; as well as tiredness and sleepiness. It is, therefore, mandatory to carefully read this manual, in particular section “3 Safety and prevention”.

3.1 GENERAL WARNINGS

3.1.1 USER OBLIGATIONS

- The user undertakes to entrust the machine only to qualified and trained personnel.
- The user undertakes to set up an electric circuit breaker with an effective regulatory earthing system and the various connections for water inlet and drain.
- The user is required to take all measures to prevent unauthorised people from using the machine.
- The user undertakes to adequately inform and train its personnel on the application and observance of the safety regulations.
- Failure to comply with these rules may jeopardise the safety of the device and IMMEDIATELY void the warranty.
- The user must inform the manufacturer if defects or malfunctions of the accident-prevention system are found, as well as any presumed dangerous situation.
- The user undertakes to use only original spare parts. Otherwise, the warranty lapses. It also undertakes not to intervene for any repair work.

3.1.2 INSTALLER OBLIGATIONS

- The thermodisinfectant must be installed and set up for use exclusively by specialised personnel and authorised by the manufacturer.
- Check that the machine has not been damaged during transport and handling.
- Use the thermodisinfectant only in environments that are not at risk of fire and/or explosion and in rooms at ambient temperature.
- Before installing the equipment, ensure that the supply voltage complies with the one shown on the identification plate and that the water supply pressure is equal to the one indicated in the technical data. Furthermore, make sure that the drain matches the dimensions provided on the installation drawing.

- The electrical and water connections can only be made by specialised technicians, paying particular attention not to crush the power supply cable and the water flexible hoses.
- Do not use the machine without securing it to the ground using the fixing kit supplied with it.
- Do not install the machine in the same room where patients are housed. The machine can heat the environment, thus increasing humidity.

3.1.3 OPERATOR OBLIGATIONS

- Before starting to operate for the first time, familiarise with the control devices and their functions.
- The operator must not carry out operations or interventions which are not within his/her competence on their own initiative.
- It is strictly forbidden to operate or have the machine operated by anyone who has not read and understood the information in this manual, as well as by unskilled personnel who are not in good mental and physical health.
- The machine must not be operated with the guards removed or partly damaged.
- Use the thermodisinfectant only for the operations described in this manual.
- Do not damage or change the power cable or plug.
- Never start the machine if the cable or plug are damaged.
- Do not pull the power cable to unplug it. Always act on the plug.
- Use detergents and additives specific for manufacturer-approved thermodisinfectants. Always observe the manufacturer's instructions. If, despite this, the product has negative effects on the instruments or machine, the responsibility will be of the manufacturer of the cleaning liquids.
- Only introduce instruments that can be treated with automatic cleaning and disinfection process (see manufacturer's instructions). It is particularly important to follow the manufacturer's instructions when inserting new instruments that are used for the first time.
- If additional accessories are used to load the instruments, especially hollow ones, the instructions contained in the manufacturer's instruction manual must be observed.
- Always use the base grid supplied with the device.
- Handle the liquid bottles with care. The cleaning, neutralisation and rinsing products contain irritants and caustic substances.
- The water in the tank is not drinkable.
- Do not lean on the door and do not use it as a step.

- The machine during its work cycle reaches a temperature of 95°C; be very careful: there may be a risk of scalding.
- Do not change, for any reason, the characteristics of the appliance, its installation specifications and the parameters set.
- At the end of loading and unloading the instruments to be used, always close the door of the washing tank in order to avoid possible unpleasant smells coming from the drain.
- In case of fire, to extinguish the flames intervene with a powder fire extinguisher, DO NOT USE WATER.
- Do not wash the machine with direct or pressure water jets, or corrosive substances.
- Do not use the machine to wash or disinfect objects and/or containers that, because of their shape or material, are not compatible with the indications given by the manufacturer. For objects to be washed, please follow the instructions explicitly indicated in this manual.
- In case of long outage periods of the machine, please cut the power supply off and close the water taps.
- Do not try to open the tank door during operation: the appliance is equipped with a special safety lock system to prevent the door from being opened.



Pay attention where indicated, for a potential danger of hot surfaces highlighted on the machine with this pictogram.



Pay the utmost attention where indicated, for a potential electrical hazard highlighted on the machine with this pictogram.

3.1.4 MAINTENANCE TECHNICIAN OBLIGATIONS

- Periodically check the integrity of the machine as a whole and the protection devices.
- Respect the laws in force in the country of use of the machine, in relation to the use and disposal of the products used for cleaning and maintenance. Dispose of any special waste through appropriate companies authorised for this purpose, with issue of a receipt of the successful disposal.
- The assembly of parts of other brands or any changes (in addition to voiding the warranty), can vary the machine characteristics and, therefore, compromise its operational safety.
- If the protective casings are removed, make sure that they are correctly restored before reusing the machine.

- At the end of the maintenance and repair operations, before restarting the machine, make sure that the work is completed, the safety devices reactivated and the guards reassembled.
- It is strictly forbidden to remove or tamper with the safety devices.
- The machine maintenance must only be performed with the power supply off, by qualified personnel and following the instructions in this manual.

4 HANDLING

Usually the packaged and palletised machine is transported to the retailer/dealer who, by means of its personnel and suitable means, in compliance with current regulations, will itself make the delivery to the end user, ensuring transport and unloading operations depending on the type of transport vehicle.

Each package, on the outside, shows the machine handling instructions in brief.

During storage or handling the contents are not sterile. Upon delivery, check that the thermosinfector is intact and that the material indicated in the delivery document is actually present. In case of damage or inaccuracies in the delivery, immediately notify the manufacturer of the extent of the damage or inconsistencies found.

Should the need arise for transfers, the machine can be easily loaded on suitable equipment and on the available lifting equipment.



HAZARD. The loading/unloading operations can be very dangerous if not carried out with the utmost care. Therefore, before starting loading/unloading, move unauthorised persons away; clear and delimit the area where the operation takes place, and check the integrity and suitability of the lifting and transportation equipment available.

Also make sure that the area of operation is clear and that there is sufficient "escape space", that is, a free and safe area, in which to move quickly in the event that the load falls. Before loading, check that there is sufficient space on the surface of the transport vehicle to accommodate the machine to be transferred.



WARNING. After loading the machine, secure it firmly to the surface on which it rests with taut ropes to block any possible movement.

After carrying out the transport and before releasing the machine from all constraints, check that the status and position cannot constitute danger. Therefore, remove the ropes and unload using the same equipment and methods used for loading.

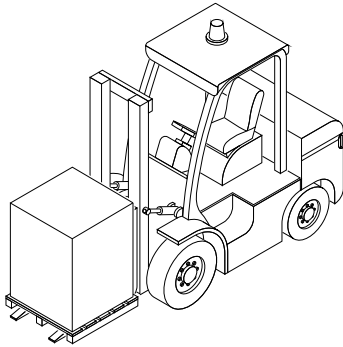

Fig. 5a

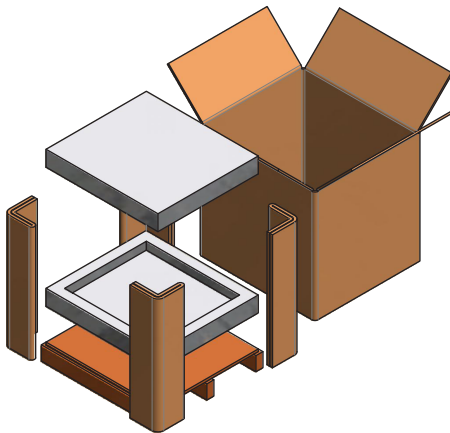

Fig. 5b



Fig. 5c

	TEMPERATURA TEMPERATURE	MIN MAX	5°C 50°C	(A)	
	UMIDITÀ HUMIDITY	MIN MAX	10% 90%	(B)	
	PRESSIONE PRESSURE	MIN MAX	70 kPa 106 kPa	(C)	
	(D)				
	(E)				
	(F)				
	(G)				
	(H)				
	(I)				
ALTO UP	FRAGILE	MANTENERE ASCIUTTO KEEP DRY	NON SOVRAPPORRE MASCHINE NARRÉE 1 MACHINES	NON CAPOVOLGERE DO NOT FLIP	NON USARE GANCI DO NOT USE HOOKS

Fig. 6

- A label is placed outside the packaging that indicates:
- A) Minimum and maximum temperature of the storage environment;
 - B) Minimum and maximum humidity of the storage environment;
 - C) Minimum and maximum pressure of the storage environment;
 - D) "High" position indicators;
 - E) Glass indicating "Fragile" material;
 - F) Keep the packaging dry;
 - G) A maximum of two machines can be stacked;
 - H) Do not overturn the packaging with the machine inside;
 - I) It is strictly forbidden to use hooks for handling the packaged machine.
- Handle the packaged machine only with forklift truck or pallet trucks with forks (Fig. 5a).
 - Remove the "hat" container (A) extracting it from the top (Fig. 5b).
 - Handle the machine with appropriate trolley. Lock the machine on the trolley with a sturdy belt (B Fig. 5c)
- Do not lift the machine by grasping it from the protruding points, such as the control panel. They may be damaged or detached. With some metal components there is a danger of injury or cuts.



WARNING. Wear cut-resistant protective gloves during manual transport and positioning of the machine.

- Inside the packaging, in addition to the machine, there are:
- the instructions for use manual
 - the two spray arms that will be applied on the tank;
 - the flexible hoses for hydraulic connections (hot water and cold water / purified water);
 - the drain pipe.

If the machine is to be moved, it is advisable to keep the packaging for any other relocation.

If this is not provided, dispose of the packaging materials: cardboard, polystyrene and other, separated by single material, sending them to the most appropriate final destination, which may be recovery or storage in landfills.

4.1 STORAGE

If the packaged machine is temporarily stored, make sure that it is not subjected to blows and tampering. However, it must be placed in a closed, dry, dust-free environment and protected from atmospheric agents. When restored, a careful preliminary examination of its integrity by specialised personnel is necessary.

Absolutely avoid overlapping weights or foreign bodies on the packaging and the machine.

5 INSTALLATION

It is advisable that only furniture for professional use be positioned in the area around the machine, to avoid ruining them due to possible leakage of condensation water.



HAZARD: Do not install and/or use the thermoisinfector in environments with flammable/explosive atmosphere.



Make sure that the floor is fit to support the load of the equipment when in operation, equal to 154,3 lbs. (70 kg). Make sure that the machine is perfectly vertical and stable, using a spirit level, if necessary.

Unevenness of the machine surface and height can be adjusted with the four adjustable feet placed under the machine itself.

There are two models of thermoisinfector (see Fig. 2): The CT model is the classic model of thermoisinfector with small-sized product bowls, which can be positioned on any piece of furniture capable of withstanding its weight, within a dental practice.

The UC model is a thermoisinfector with much more capable product bowls than the TIVA2-C version and which, usually, is embedded under a piece of furniture where appropriate space is already provided, within a dental practice.



HAZARD: All electrical and water connections (loading/unloading) can only be carried out by specialised and authorised personnel and by consulting the relative diagrams.

Before machine positioning make sure that:

All the components needed for installation and proper use of the machine were installed: main switch, water supply taps, drain and anything else needed. These components should have all the needed features and should be installed at the locations shown on the installation scheme.



WARNING: The use of unsuitable parts, and/or the implementation of installation procedures other than those shown on the installation diagram, will immediately void the machine warranty.

The characteristics of the electricity network must be compatible with the values required for correct operation indicated on the machine identification plate and on the technical data sheet.

The machine must be connected to an efficient earthing system (according to electrical safety standards).



The manufacturer is not to be held liable for any damage caused by improper earthing of the machine or faulty power supply.

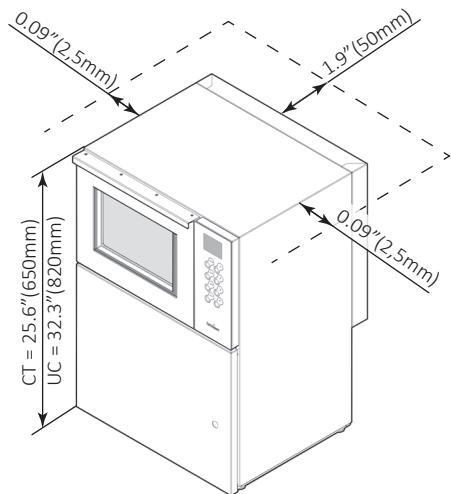

Fig. 7

5.1 BUILT-IN INSTALLATION

The built-in machine can be inserted under a continuous worktop or under the sink's drip surface. The recess niche must have a minimum space as shown in figure 7. The presence of adequate air intakes must be guaranteed to allow the ventilation of the area behind the machine, in order to avoid creating a closed space without exchange of air with the room environment.

5.2 STAND-ALONE INSTALLATION

If the UC machine is positioned isolated with respect to a worktop, i.e. it is resting on its feet and not inserted in a niche, it is important to remember to fix the machine to the ground using plugs or equivalent fixings to ensure that it is not overturn if pushed on its longer side. The lower compartment contains holes that can be used to perform this operation.



The manufacturer declines any liability for damage to things and/or people caused by the machine falling due to the fact that it is not fixed to the ground.

5.3 ELECTRICAL CONNECTION



HAZARD. Only qualified and experienced personnel can connect the machine to the mains supply, in compliance with the current laws and regulations.



WARNING: In the single-phase version, the main switch of the power supply line must be a multi-pole circuit breaker, with adequate residual current protection.



WARNING: In the three-phase version, the main switch must be multi-pole circuit breaker, with adequate residual current protection, positioned near the machine and not covered by machines or other that may hinder its use.

The magnetic-snap safety system, or the fuses, must be calibrated according to the power indicated on the machine plate.

- Make sure that the measured voltage is equal to the one reported on the identification plate of the machine;
- Check that the voltage does not differ by more than 10% from its rated value;

- Make sure that the electrical system is equipped with an efficient earthing connection;
- Connect the cable that comes out of the machine to the wall socket. In case the machine has a three-phase connection (on request), connect the cable installed on the machine to the three-phase plug (not supplied) and insert it into the interlocked socket next to the machine (not provided).
- The socket must be accessible after the machine installation. This facilitates verification of the electrical safety, e.g. in repair or maintenance interventions.
- The machine must be supplied with current whose voltage, frequency and protection values correspond to those indicated on the data plate.
- The wiring diagram can be downloaded from the manufacturer's website. Additional indications regarding the electrical connection are shown in the installation diagram. This can also be downloaded from the manufacturer's website.





Any damaged fuses must be replaced by authorised personnel. See Annex 9.10 for their value and size.

5.3.1 ELECTRICAL CONNECTION

Connection of the machine to the electrical mains must be made by qualified, skilled personnel.



Power supply cable: it is compulsory for the retailer - installer to adapt the insulation class of the power supply cable to suit the working environment in compliance with current technical regulations.

- Check that the electric specifications match those shown in the label. 
- The electrical connection must be carried out in compliance with current technical regulations. 
- Make sure that the mains voltage reading corresponds to the voltage indicated on the machine plate.
- Check that the power supply voltage does not differ by more than 10% from its nominal value.
- The frequency of the power supply voltage must not differ by more than 1% of its value.
- Connection of the machine to the mains must be provided with an earth connection and an equipotential circuit as set forth by current standards.
- Make sure that the electrical systems are efficiently earthed.
- The earth conductor is to be connected to the earth terminal identified by the standard symbol.

- The machine is equipped with a terminal identified by the relative symbol for equipotential connections between appliances (see rules for electrical plants).
- Connect the machine and the relative dedicated safety device (not supplied) by using a power cable compatible with the electrical characteristics of the machine.
- In case of prolonged use of the machine it is recommended that you execute the disconnection procedure of the electrical connection by placing the dedicated safety device in "OFF" state.
- The upstream electrical power line must be dimensioned and protected in accordance with current local regulations.

Electromagnetic compatibility (EMC)

The machine has been tested on electromagnetic compatibility (EMC) pursuant to Standards IEC 61326-1 + EN 61326-1 and is suitable for operation in institutes such as hospitals, medical practices, laboratories and environments connected to the public electricity grid.

The high-frequency (HF) energy emissions of the machine are so small that interferences with electrotechnical equipment in the immediate vicinity are not likely.

The optimal positioning floor must be made of concrete, wood or ceramic tiles. In case of machine operation on floors made of synthetic materials, the relative humidity must be 30% to minimise the likelihood of electrostatic discharges.

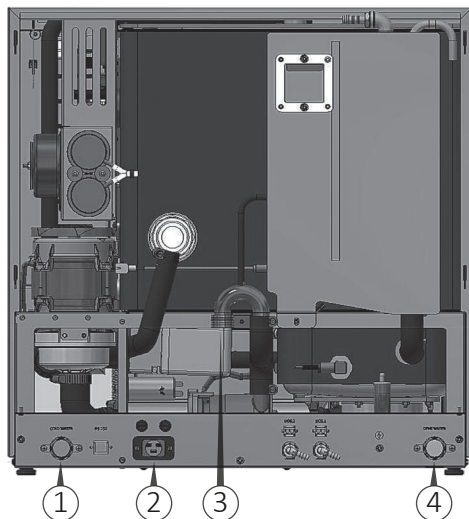

Fig. 8

Connections (rear view of the machine)

- 1) Cold water connection.
- 2) Power supply socket.
- 3) Drain connection.
- 4) Cold or purified water connection (depending on the sales configuration).

5.4 WATER CONNECTION



CAUTION: The water in the wash tank is not drinkable.

The quality of the water used must be compatible with the manufacturing materials of the machine, with the chemicals and with the process needs in the various stages of the procedure.

To have good washing results, the water must be soft and low in limestone. With hard water white patinas deposit on the objects to be treated and on the walls of the wash tank. Starting from a water hardness of 0.7 mmol/l (4°dH) it is necessary to soften the water. Water hardness is set by technical assistance/Super User.

The water used in the pre-rinse and washing stage should be of drinking quality according to the "Guidelines for drinking-water quality, 3rd edition" published by the WHO. A high iron content can cause rust on the load and in the special washing and disinfecting machine. If industrial water contains a higher amount of chlorides than 100 mg/l, the risk of corrosion significantly increases.

The special washing and disinfecting machine is standard prepared for connection to cold and purified water. Connect the flow pipes to the shut-off valves for cold or purified water.

The minimum flow pressure corresponds:

- cold water connection: 200 kPa;
- purified water connection: 200 kPa;
- hot water connection: 200 kPa.

The recommended flow pressure in:

- cold water connection: 300 kPa;
- purified water connection: 300 kPa;
- hot water connection: 300 kPa.

The max. static water pressure allowed is 500 kPa.

- The machine must be connected to the water mains in accordance with current regulations.
- If the water supply of the device has not been used for a long time, or if it is used for the first time, purge it by draining the water into a container or into a drain for a few minutes in order to remove any impurities, air bubbles and/or whatever may damage the machine and clog its filters.

- Connect the cold and purified (if available) water hoses, exiting the machine with their respective network connections, as shown on the installation diagram. It will be the responsibility of the installer to make sure that the temperature of the cold water supply is not higher than 5/15°C, otherwise proper washing of materials cannot be ensured. The connections for cold and purified water must not feed any equipment other than the instruments washer. During the washing cycle, this is necessary to prevent the subdivision of the water supply with other users, thus leading to a substantial increase in the time required to fill the tank (in this case an alarm will be triggered to alert the user that the maximum time allowed for water loading is exceeded).
- If the machine is provided with a purified water feeding system but the plant is not equipped with it, the cold and purified water hoses should be connected together.
- The machine can be equipped with a built-in softener, which has the function of reducing the scale in the water supplied
- Connect the flexible hoses to the machine valves positioned in view at the back, making sure to connect them correctly based on the sales configuration.
- Make sure to connect the water flexible hoses in the positions shown in figure 8.
- Connect the cold water flexible hose to connection 1 in figure 8.
- Connect the purified water flexible hose (if any), to connection 4 in figure 8.



WARNING. The flow pipes must not be shortened or damaged.

The water supply taps must be capable of quickly stopping the water line, therefore, they must be equipped with a ball or a gate valve. They must also withstand the operating pressure of the water, as indicated in the technical data sheet.

The installer must check the water hardness which must be 0.7 mmol/l (4 °dH). Possibly use a softener.

Water hardness conversion table:

Hardness expressed in French degrees (°fH)	Water hardness (mmol/l)	Hardness expressed in German degrees (°dH)
0-10	0-1.01	0-5.60
11-15	1.11-1.51	6.16-8.40
16-20	1.61-2.02	8.96-11.20
21-25	2.12-2.52	11.76-14.00
26-30	2.62-3.03	14.56-16.80

Hardness expressed in French degrees (°fH)	Water hardness (mmol/l)	Hardness expressed in German degrees (°dH)
31-35	0-5.60	17.36-19.60
36-40	6.16-8.40	20.16-22.40
41-45	8.96-11.20	22.96-25.20
46-50	11.76-14.00	25.76-28.00
51-55	14.56-16.80	28.56-30.80
56-60	5.66-6.06	31.36-33.60

Proper placement of the taps is shown on the device installation drawing that can be downloaded from the manufacturer's website.

Models with built-in water softener

The integrated function of the softener is used to reduce the amount of limescale contained in the incoming water. If the machine is connected with hard water, the result is a rapid degeneration with loss of function and performance.

Regeneration must be performed to keep the ionic resins active.

For machines equipped with a water softener, when installed, it is necessary to enter the water hardness value by entering in programming menu.

Hardness expressed in French degrees (°fH)	Setting parameter	Regeneration
0-10	Value 0	No regeneration
11-15	Value 13	every 13 cycles
16-20	Value 11	every 11 cycles
21-25	Value 9	every 9 cycles
26-30	Value 8	every 8 cycles
31-35	Value 7	every 7 cycles
36-40	Value 6	every 6 cycles
41-45	Value 5	every 5 cycles
46-50	Value 4	every 4 cycles
51-55	Value 3	every 3 cycles
56-60	Value 1	*Regeneration at every cycle

*) Recommended only for expert users.

See chapters 5.5.3, 5.5.4 and 5.5.5 for salt refill and regeneration.



WARNING. During this operation, check that the plastic cap is closed.

Insert the basket and start a normal washing cycle. The machine regenerates automatically.



WARNING. The washing cycle performed after the «salt loading» may not work.



Fig. 9

Filter unit (Fig. 9):

- 1) Central filter. - 2) Mesh filter. - 3) Tank bottom filter.
- 4) Salt tank cap.

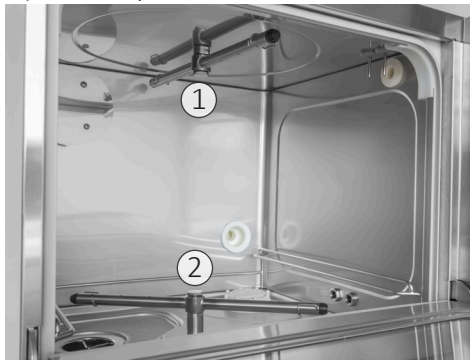

Fig. 10a

Spray arms (Fig. 10a):

- 1) Upper spray arm. - 2) Lower spray arm.

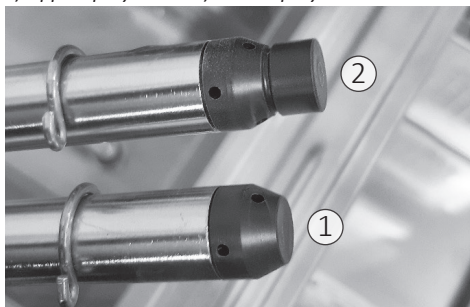

Fig. 10b

Spray arm rotation identification (Fig. 10b):

- 1) Spray arm without magnet for identification. 2) Spray arm equipped with magnet for identification.

5.4.1 CONNECTION TO THE WATER DRAIN

The machine is equipped with a built-in drain trap which must be mandatorily connected to the drain system of the building.

The correct positioning and sizing of the drain trap are shown on the installation drawing (See Annex 9.1). The user must carry out periodic maintenance of the drains and check that they are not clogged.

If not already connected, connect the grey drain pipe to the drain connection located at the back of the machine (3 Fig. 8).



WARNING. The manufacturer is not liable in case of environmental pollution due to an incorrect use of the thermodisinfector.

5.5 FILTERS, SPRAY ARMS AND REGENERATION SALT

5.5.1 FILTERS

Insert the supplied filters in the specific positions. Constantly check the cleanliness of the filters, especially the tank bottom filter (3 Fig. 9).

Use this filter to have a high filtering, taking into account that it will have to be cleaned after each cycle performed to avoid an excessive build-up of dirt.

Insert the mesh filter (2 Fig. 9) and place it in the tank seat. Finally, insert the central filter (1 Fig. 9) in the mesh filter hole.

5.5.2 SPRAY ARMS

The two spray arms are supplied loose to avoid possible breakage during transport. Place the two spray arms (top and bottom) in their seats and tighten them to the relative central pin inside the tank as shown in Fig. 10.

- After fixing the spray arms, carry out a test by manually turning it, making sure that they rotate freely and without impediments.



WARNING: For versions with spray arm rotation control, the spray arm with the magnet must be positioned below (1 Fig. 10b).

- After machine positioning, make sure nothing is preventing the tank door from being freely opened.
- Make sure the machine is connected properly to the electrical supply, to the water supply and to the drain

trap, then level it by adjusting its feet.

- After installation remove the PVC protection layer covering the panels, make sure the liquid tanks are full and the suction nozzles are properly inserted into the right tanks. A label next to the cap indicates the type of liquid to be used for each suction tube.



WARNING: Spray arm assembly direction, the water outlet holes must face towards the inside of the tank otherwise the spray arms will NOT work.

5.5.3 REGENERATION SALT

The Thermodisinfecter is supplied without regeneration salt which will feed the device automatically during the regeneration process.

The salt must be introduced through the tank outlet inside the tank (4 Fig. 9). To introduce the salt, unscrew the cap (anti-clockwise) and fill the tank with salt, paying attention not to pour salt outside the bowl then close the tank with the cap.

You must fill the salt tank every time the message "Refill salt" is displayed.

- Use only appropriate coarse-grain salt.
- Do not use kitchen salt, crushed salt tabs or other types different from those indicated, as it may contain insoluble substances.
- Do not pour cleaning liquids or other solutions in the salt tank.



Failure to comply with these recommendations can lead to a malfunction of the water softening device. Just before the salt runs out completely, the display will show the message «Lack of salt». At this point, the salt should be topped-up as soon as possible, otherwise an error message will appear and it will no longer be possible to activate a new cycle if not by resetting.

5.5.4 SALT REFILL

Proceed as follows to refill the salt:

- 1) Delete the message on the display by pressing the RESET key for 5 seconds.
- 2) Open the door and remove any already inserted load.
- 3) Loosen the salt tank cap and insert the funnel.
- 4) In the first filling, introduce 1,3 US gal (0,5 l) of water to dissolve the residue salt. **FIRST FILLING ONLY**
- 5) Fill with salt up to the edge. The tank contains about 1,5 lbs. (0,7 kg) of salt.
- 6) Thoroughly clean the edge of the tank.

7) Tighten the cap again.

8) Start the «Rinse» cycle.

- It is absolutely necessary to remove any salt residues that may have settled in the tank after refill and before rinsing.
- After each top-up, start the «Rinse» program. In this way, any salt grains will dilute and rinse out. Salt residues and the overflowing water and salt solution can cause corrosion if they are not rinsed.

Following the instructions in the start-up paragraph, start the «Rinse» program.

5.5.5 AUTOMATIC REGENERATION

It is possible to have a water softening device that can completely regenerate at precise intervals. This process is fully automatic. Regeneration will be implemented before the selected program is activated.

This device must be preset by the technician during installation.

Regeneration can also be performed manually, regardless of the warning message on the display. To start, select the «Regeneration» program.

5.6 CHEMICALS

The dosing system for chemicals consists of:

- Standard: A dosing pump for the detergent (a neutral or alkaline detergent is recommended).
 - Optional: A dosing pump for the neutraliser. This pump set on the acid neutralising additive can also be used for dosing the rinse aid. In this case the installer must reset the device commands and modify the dosing pump.
 - Under-the-counter: In this version it is possible to have up to three pumps for three different products. Each dosing pump is monitored by a dosing volume control. This electronic control checks the dosing amount.
- In the event of a lack of product, a message appears on the display and the program stops.



WARNING. It is recommended to handle the liquids with caution.

- Protect eyes, hands, clothes and metal surface from contact with liquids, which contain partially irritating agents and caustic substances.
- In case of contact with liquids, consult the instructions provided with the product.
- Use only suitable liquids for cleaning and disinfection equipment. Carefully follow the manufacturer's information.

- Keep chemicals out of the reach of children and outsiders. Possibly locked away.
- Use on only the manufacturer's approved products.
- Do not use liquids for household dishwashers.

The liquid containers are positioned at the bottom of the machine, inside a door closed with a key (Fig. 11). Open the lower door of the machine with the key.

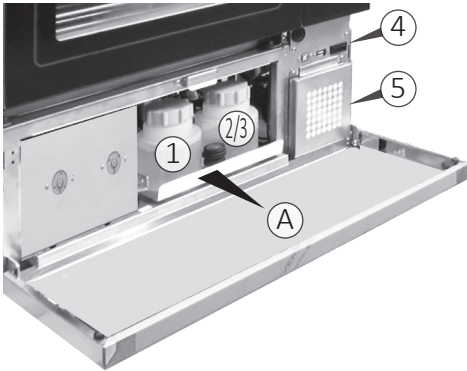

Fig. 11a

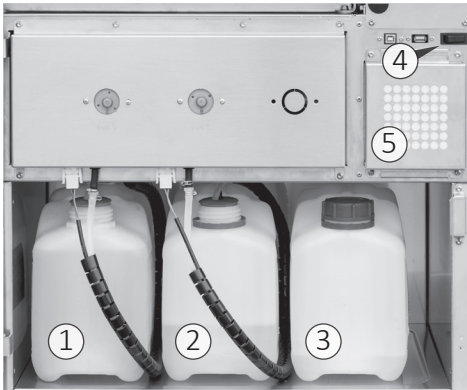

Fig. 11b

Product containers

- A) Drawer extraction direction. - 1) DOS1 detergent liquid container. - 2) DOS2 neutralising liquid container. - 3) DOS3 Rinsing liquid containers. - 4) ON-OFF switch. - 5) Air suction filter.

5.6.1 REFILL PROCEDURE

For the countertop thermodisinfectant:

- Pull and extract the drawer manually (A Fig. 11);
- Loosen the cap with container 1 tube (or 2/3);
- Fill the container with the related chemicals.
- «Detergent»
- «Neutraliser / Rinse aid».
- Tighten the cap well and put the drawer back in its position.

For the under-the-counter thermodisinfectant:

- Set up a new tank with the chemical;
- Extract the empty tank 1 or 2 or 3 (Fig. 11);
- Remove the tube and place it on a non delicate and easy to clean surface;
- Insert the tube in the relative tank and put it back in the corresponding position:

- «Detergent»
- «Neutraliser»
- «Rinse aid».

See the chapter 6.1.1 for loading the chemicals.

Be careful not to reverse the position of the liquids.

Failure to follow these recommendations may damage the thermodisinfectant.

- With regard to the maximum dosage for each program, follow the instructions of the chemical manufacturer.
- To ensure efficiency of the dosing system, it is necessary to regularly carry out the maintenance operations set out in the «Maintenance» chapter.
- The indications concerning the storage and disposal of chemical substances are provided by the respective manufacturers and must be observed.
- Do not place the chemical containers on the thermodisinfectant.

Completely empty the thermodisinfectant before performing maintenance and before moving the machine to avoid contact with the chemicals and to protect the machine components.

5.6.2 USING AND STORING CHEMICALS

Keep the containers tightly closed, stored in a dry place and protected from the sun, out of reach of children and outsiders. Possibly locked away. Optimal storage temperature: check the chemicals datasheet. The shelf life in the original containers is indicated on the chemicals' labels. The manufacturer recommends a method for inventory management (first in- first out).

The thermodisinfectant can use up to three products (two in the over-counter version) for dosing liquids.

The manufacturer recommends using cleaning agents and chemical additives. The use of other products can damage the machine.

The flow meters of chemicals are calibrated according to the density of these tested products which ensure correct operation.

The following combinations of process fluids have been tested to verify the compatibility of the materials with the components inside the device, for devices placed on the market starting from the 1st of July 2019.

Liquids recommended:

Manufacturer	Detergent	Neutraliser	Rinse aid
Borer ⁽¹⁾	Deconex Prozyme Alka-X		Deconex 64 Neutradry
Tuttnauer	Tuttnauer Alkaline Detergent	Tuttnauer Neutralizing Agent	

1) For the manual pre cleaning of the instruments stored inside the cassettes use: Borer Deconex Prozyme Active.

When chemical levels are low, a warning message appears on the display.

Chemical products dosing is set to an average value as recommended by the manufacturer.

When the actual dosing of the chemical exceeds the tolerance of 5%, the system goes into alarm.

 **WARNING:** Use only the chemical products indicated in the table. The use of non-certified products will void the warranty.

6 USING THE MACHINE

Before starting the machine, the operator in charge must have read and understood this whole manual, in particular the information given in section «3 Safety and prevention».

Furthermore, before starting work, check that the machine is in order and that all parts subject to wear and deterioration are fully efficient.

6.1 COMMISSIONING INSTRUCTIONS

These control operations (reported below) are performed to check if the machine works properly and should be performed when the machine installation is completed.

1) Open the tap that supplies water to the machine.

 **WARNING.** The water should NOT flow into the tank; otherwise the water loading solenoid valves (in the lower compartment of the machine) are dirty or blocked due to long storage in the warehouse and therefore they must be cleaned. Check that there are no water leaks in the pipe fittings.

- 2) Check that the suction tubes (located in the lower part of the machine) within the corresponding containers/tanks containing the liquids provided (detergent, neutraliser, and/or others), are correctly inserted (only UC version).
- 3) Using the main circuit breaker, supply power to the machine.
- 4) Check that the water supply flexible hoses are properly connected.
- 5) Start the machine using the ON-OFF switch (1 Fig. 13).
- 6) At the beginning of the first cycle check the level probes of the liquid suction tubes (detergent, neutraliser and/or others): pull one tube at a time out of the container and check if the corresponding alarm flashes on the display, indicating the need for liquid refilling (only UC version).
- 7) After running 3-4 washing tests, clean the water filters placed in the lower compartment of the machine (Fig. 9).
- 8) Check that the drain trap does not show water leaks and is firmly secured to both the machine and the drain.
- 9) Check if the pumps correctly suck washing liquids. To do this, check that the liquid rises along the tube connected to them.

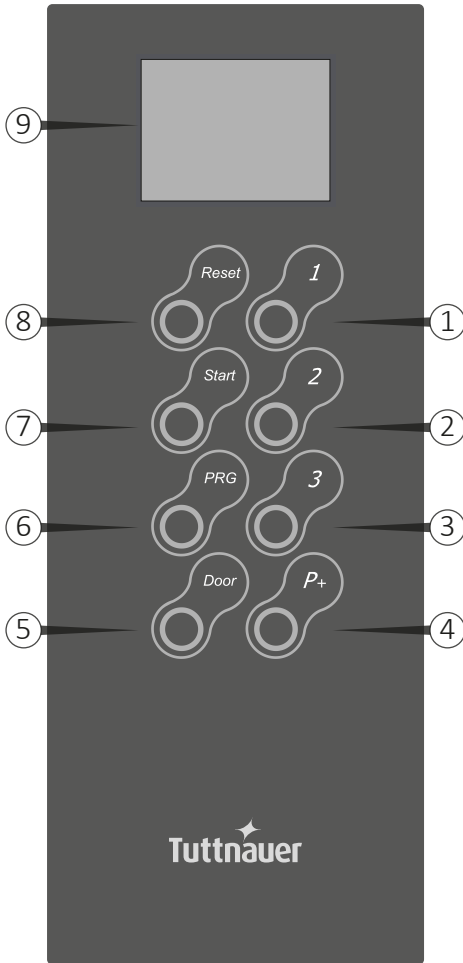

Fig. 12

6.1.1 LOADING THE CHEMICALS

When filling the liquids in the containers or changing tanks, it is required to perform the manual filling of the hydraulic circuit. This phase is important because it prevents any air bubbles present in the pipes from causing an interruption of the cycle following an incorrect reading of the flow meters.

To fill the pipes after changing or refilling the chemicals, proceed as follows:

- 1) Open the door using the "DOOR" button on the touch screen, if the door is already open, leave it fully opened;

- 2) Remove the basket if inserted, in order to have full visibility of the washing chamber;
- 3) Depending on the machine configuration: 1 pump, 2 pumps or 3 metering pumps;
- 4) Press and hold the button corresponding to the metering pump you wish to activate to manually load the hydraulic system: key 1 on the touch screen for pump 1, key 2 on the touch screen for pump 2 and key 3 on the touch screen for pump 3.
- 5) Wait a few seconds to see in the lower right part, the area where the chemical inlet holes (3 Fig. 14) are present, a constant flow free from air bubbles.
- 6) Release the button and repeat the sequence from 4 to 5 for the other metering pumps that need to recharge the hydraulic circuit.



Important: this phase must be performed at the first installation of the machine, in this case, let the liquid flow for a few more seconds to ensure the correct and full loading of the hydraulic system.

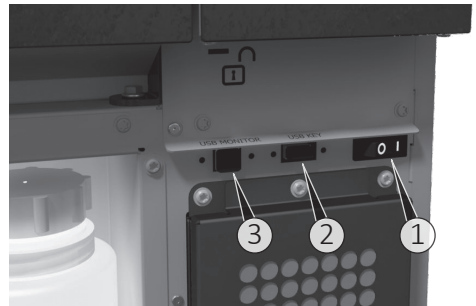

Fig. 13a

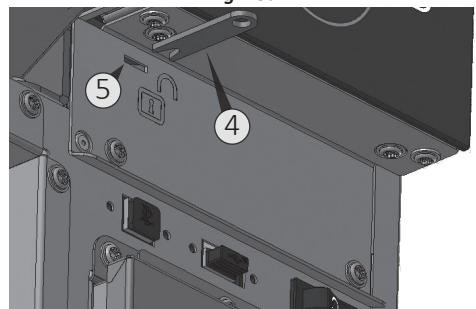

Fig. 13b

- 1) ON-OFF switch. - 2) USB pendrive port for inserting or extracting the pre-filled programs. - 3) USB port for PC connection. - 4) Key for emergency release. - 5) Hole for emergency release.

6.2 BEFORE USE

The thermodisinfectant can be used for cleaning and disinfecting:

- Medical instruments.
- Keys, trays, containers.
- Hollow instruments, e.g. suction cannulas, fixing them to the appropriate supports, using the suitable adapters.

6.2.1 EMERGENCY RELEASE

In the event of a blackout, or any other need in which it becomes difficult to open the thermodisinfectant door, there is a manual emergency release that can only be activated if the door cannot be opened normally.



HAZARD. *If the emergency release is used while a program is running, very hot water and chemicals may leak. Therefore, there is a danger of burns, scalding and irritation.*

To access the emergency release:

- open the lower door of the machine with the key;
- insert the key into the hole (4 Fig. 13b);
- upon the door unlock take out the key (5 Fig. 13b).

In case of program interruption, proceed with a new treatment of the load.

6.2.2 PREPARING THE LOAD



WARNING. *The maximum weight that the open door can withstand is 12 Kg. The maximum volume available is 0.065 m³ or 65 L. The maximum volume of the basket is 0.025 m³ or 25 L.*

The instruments to be washed must be placed on the relative basket, making sure that they do not overlap one another.

- Empty any residual liquids from the instruments and containers before inserting them in the tank, washing all residues well, e.g. disinfectant solutions and in cold water.
- Insert the individual instruments in the appropriate supports or baskets and never directly into the base basket.
- Make sure that the instruments do not come out of the containers.
- Make sure that the instruments do not hang from the grid bars.
- Insert the hollow instruments into the appropriate injectors.
- The rinse arms must be free to rotate.

- The cleaning quality depends on the correct loading of the instruments.
- Position container-shaped objects so that liquids can flow easily and, if possible, place tall and heavy tools in the centre of the trolley.
- Components with special geometries must be arranged so as to allow the water to flow out.
- Introduce only suitable steel instruments, resistant to corrosion.
- Introduce only plastic components thermostable up to 95°C.
- To prevent possible corrosion, we recommend using only stainless steel instruments and tools, suitable for washing.
- Nickel-plated and chrome-plated and/or aluminium instruments and tools may not always be suitable for machine treatment. They require special process conditions.



The instruments to be washed must first be rinsed in cold water and then placed in the drawers for washing. After use, they should be placed on a settling tank for the time necessary to bring them to the rinse area.

6.2.3 BORER CHEMICALS

For the instruments that will be washed inside the cassette see below an example of a suggested cassette:

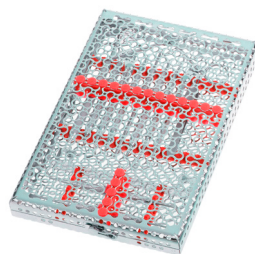

Fig. 14

Objects made completely or partially of plastic must be resistant to high temperatures.

- Before loading the machine, remove substances such as composites, cement and amalgam in compliance with current directives.
- Transmission instruments with fibre optic rod are considered resistant, while fibre optic beams may be subject to premature wear.
- If possible, disassemble the modular instruments following the manufacturer's instructions and treat the individual parts separately.

- Treat small instruments and parts in special inserts or closable baskets.
- Before the automatic treatment, check that the lumen and hollow body instruments can be treated internally and remove any obstructions.
- Carefully place the load in the supports.
- Objects must not be put inside each other nor cover each other. Do not place objects so close to each other that they cannot be washed properly.
- Arrange the load so that all surfaces can be reached by the washing liquid. Otherwise they will not be cleaned!
- Place the objects so that the liquids can flow out without hindrance.
- Place tall or heavy objects in the centre of the basket.
- When arranging the load, make sure that the spray arms are not blocked by the load itself.
- Distribute the objects evenly in the baskets.

When the base grid is used together with the injectors, make sure to push the grid all the way back against the rear wall of the tank, so that the injectors can be perfectly fixed on their connection tube at the bottom of the tank itself.



Fig. 15a



Fig. 15b

Basket insertion.

1) Basket support lanes. - 2) Basket extraction and/or insertion direction. - 3) Chemical inlet holes.

6.2.4 SUMMARY OF THE BASKET LOADING OPERATIONS

Instruments: Trays

Insert type: Tray holder insert

Sequence:

- Fill the insert by arranging the trays in the specific slots;
- Insert the insert in the basket;
- Insert the basket in the tank up to the stop;
- Close the door, start the program.

Instruments: Surgical Instruments

Insert type: Instrument holder insert

Sequence:

- Fill the insert by placing the trays in the appropriate slots upside down;
- Insert the insert in the basket;
- Insert the basket in the tank up to the stop;
- Close the door, start the program.



HAZARD. Be very careful when inserting pointed or sharp instruments. Always insert the instruments starting from the bottom, and possibly wearing protective gloves.



Perforated baskets and supports do not provide protection against pointed and/or sharp instruments.



WARNING. Failure to follow these recommendations may cause injury. Pay the utmost attention when loading/unloading the instruments to be washed.

6.2.5 TREATMENT OF DENTAL INSTRUMENTS



WARNING. Insert only instruments suitable for automatic treatment in thermodisinfectors, according to the manufacturer's instructions. In particular, follow the information provided by the same manufacturer. Despite compliance with the manufacturer's instructions, in case of damage or alteration of the instruments, the responsibility will be borne by the instrument manufacturer.

Correct program

Before starting the treatment, check that:

- The external surface of the instruments is clean of material residues (E.g. dental cement, etc.).
- The air and spray channels must be clean.
- Finally, carry out a test.

Use the recommended liquids (see paragraph 5.5.2).

Care of the instruments

Major manufacturers recommend drying the spray/air/water channels immediately after cleaning and disinfection using clean compressed air with suitable maintenance products.

It is recommended to follow the specific instructions.

6.2.6 TREATMENT OF OPHTHALMIC INSTRUMENTS

- Only insert instruments designed for automatic treatment in thermodisinfectors. Carefully follow the instructions provided by the instrument manufacturer.
- Do not insert instruments intended for interventions on the optic nerve and which come into contact with the retinal tissue.

In case of damage or alteration of the instruments despite compliance with the manufacturer's instructions, the responsibility will still be borne by the instrument manufacturer.



WARNING. The treatment of ophthalmic instruments requires the use of purified water.

Comply with the following for automatic treatment:

- Use a slightly alkaline liquid for cleaning. Use a citric acid-based neutraliser for neutralisation. Never use liquids for rinsing.
- Rinse the hollow instruments after the application and check that the purified water passage is free before the automatic treatment.
- Insert the hollow instruments into the rinse bar, specially designed for this use.
- Make sure that no deposits form on the instruments.
- Dry the hollow instruments with compressed air after the treatment in order to remove all residual humidity.
- Follow the manufacturer's instructions with regard to the maintenance of instruments/accessories for loading.

6.3 PROGRAMS

The machine leaves the factory programmed with five separate use programs already entered in the settings menu.

To select the programs available, use key 1, 2 or 3 (on the control panel Fig. 12) depending on the most suitable program for the level of dirt of the load.

The following table shows the correct programs for each type of load.

Program	Use
P1 SHORT	Certificated washing and disinfection program suitable for the treatment of instruments lightly soiled.
P2 STANDARD	Certificated washing and disinfection program suitable for the treatment of instruments moderately soiled.
P3 INTENSIVE	Certificated washing and disinfection program suitable for the treatment of instruments heavily soiled.
P4 RINSE	For rinsing the solution of water and salt of cold water, particularly dirty load, e.g.: to eliminate coarse dirt or disinfectant residues before treatment and to prevent dirt from drying or the formation of lime-scale until a complete program is started.
P5 DRYING	Additional drying.
P6 ?????	
P7 ?????	

Program structure:

- Drain: It is used to empty the washing tank.
- Pre-wash: Pre-wash is necessary to eliminate coarse dirt and foamy substances.
- Wash: Depending on the load, washing normally takes place at 45°C - 65°C, adding the appropriate detergent.
- Rinse: The rinsing operation eliminates and neutralises the chemicals of previous washes.
- Disinfection: To prevent the load from being subject to corrosion or patinas, purified water (if available) should be used during the disinfection phase.
- Drying: Sufficient drying reduces the risk of corrosion caused by the residual humidity on the load.

For programs details see Annex 9.3.

6.4 STARTING THE MACHINE

After checking the integrity and full efficiency of the machine, proceed with start-up.

- 1) Power the machine using the main circuit breaker.
- 2) Start the machine using the ON-OFF switch (1 Fig. 13) and open the door (key 5 Fig. 12) to introduce the baskets.

6.4.1 BEFORE STARTING THE PROGRAM

Before starting each program, check:

- Check that the filters, positioned on the bottom of the tank (Fig. 9) are perfectly clean. Clean them, if necessary.
- The nozzles of the upper and lower spray arms must be free and clean.
- Basket and products must be arranged correctly.
- The spray arms must be able to rotate freely. The machine constantly monitors the rotation speed during the program.
- Liquid containers must be sufficiently filled. Check for any messages on the display before starting the program.

Closing the door

- Introduce the basket and load the instruments.
- Close the door and push it until the lock is activated. The door can be unlocked and opened at any time before the program starts, by pressing the key (5 Fig. 12).

Selecting the program

To select the programs available, use key 1, 2, 3 or the key P+ (to select programs from 4 to 40) on the control panel (Fig. 12).

Choose the most suitable program depending on the level of dirt on the products to be washed.

See chapter 6.3

6.4.2 STARTING THE PROGRAM



WARNING. Always follow the indicated procedures. Inattentive and superficial use of electrical devices may lead to risks for the operator.

The manufacturer is not liable for possible damage caused by uncontrolled use of the device.

After selecting the program with relative key, the display shows the selected program and the operating time and temperature.

To start a program, press the START key (7 Fig. 12).

Program execution

Once the program has started, its progress can be followed on the display. The display shows the program phases during operations.

Pre-wash

Pre-wash is carried out with cold water (optional softened water) and without liquids. It mechanically dissolves encrusted organic materials and all proteins on the surface of the instruments. Avoid too high water temperatures.

Wash

It is the actual cleaning cycle. The cleaning tank heats up until it reaches the specific temperature for the selected program, a temperature that remains stable for the holding time. The cleaning liquid is automatically introduced before the start of the holding time.

Rinse

Rinsing is carried out with cold water, if the machine is equipped with the second pump (optional) it is possible to carry out the neutralisation cycle by introducing neutralising liquid which is designed to reduce the alkalinity and clean the instruments from residues soluble in acid, e.g. limestone and rust.

Disinfection

Thermo-disinfection is carried out with deionised water, depending on the setup of the machine, it is possible to introduce the rinse aid to improve the drying phase.



The thermodisinfector is equipped with a product container with relative pump (1 Fig. 15) for the detergent liquid. On request, it can be equipped with a second container (2/3 Fig. 15) used for the neutralising liquid or rinse aid.

The under-the-counter thermodisinfector is equipped with three tanks (Fig. 15), with relative pumps, for greater capacity of the liquids where tank 1 will contain the detergent liquid, tank 2 the neutraliser and tank 3 the rinse aid.

Drying

The instruments are dried internally and externally with filtered hot air. Good drying reduces the risk of corrosion caused by the residual humidity on the load. Instruments with a very small internal diameter must be dried further.



WARNING. *The program can be interrupted at any time. However, it must be remembered that once interrupted, it must restart from the beginning. Only if it is interrupted in the drying phase can the cycle be considered completed successfully. The instruments must be dried.*



IMPORTANT: *In the EcoDrying version, the machine will interrupt the cycle at the end of the disinfection. It is the responsibility of the user to dry the instruments that have just been washed, using suitable cloths and following the instructions contained in the instruction manual for each individual instrument washed. The manufacturer declines any liability for contamination of the instruments during the manual drying stage.*



IMPORTANT: *In the EcoDrying version, the instruments must NOT be left inside the machine, at the end of the cycle, wet, for longer than 5 minutes. This is to prevent the proliferation of bacteria and microorganisms.*

6.4.3 PROGRAM END

The message «Successfully completed» on the display indicates that the program has been carried out correctly. Unlock the door by pressing the key (5 Fig. 12) and open it.



Open the door immediately after the end of the program to avoid condensation forming.

Check the results at the end of the cleaning process. The instruments must be completely clean and dry.



Hollow instruments with a small internal diameter must be dried further with air.

- Check hollow instruments and retreat them if necessary.
- The hole (lumen) of hollow instruments must be free.
- The injectors must be correctly placed on the connection tube in the cleaning chamber.
- The nozzles and connections to the base grid must be firmly fixed.

If these checks are positive and the program has been carried out without interruptions or malfunctions, the load has been successfully cleaned and disinfected.

6.4.4 EXTRACTING THE LOAD

At the end of the program and when extracting the load:



Do not force to open the door to avoid damaging the device and/or the leak of toxic steam.



Particularly large instruments can be very hot at the end of the program. Allow instruments, containers and inserts to cool down before removing them.

Failure to follow these recommendations can cause burns.

6.5 CONTROL PANEL

The control panel consists of 8 keys and a 3.5 inch LCD display. All keys, except key "3", are multi-function, depending on the action being performed.

Description of the control panel (Fig. 15):

RESET | A

To use for:

- stop a running program;
- return to the previous menu item;
- "A" character for the custom password.

START | B | ENTER

To use for:

- enter the selected menu item;
- continue to the next parameter;
- "B" character for the custom password.

PRG | C

To use for:

- enter to the program menu;
- "C" character for the custom password.

DOOR | ESC

To use for:

- open the door at the end of the program;
- exit from parameters and programs.

1 | + | ↑

To use for:

- "1" character for the custom password;
- select program 1;
- navigate upward in the menu;
- change the value of the highlighted parameter.

2 | - | ↓

To use for:

- "2" character for the custom password;
- select program 2;
- navigate forward in the menu;
- change the value of the highlighted parameter.

3

To use for:

- "3" character for the custom password;
- select program 3;

P+ | CANCEL

To use for:

- delete incorrectly typed field;
- select the next program (proceeding by +1 at a time upon program 40).

6.5.1 COLORS OF THE KEYS

Depending on the active function, the keys get highlighted with coloured lights:

- White light: indicates the keys that can be used in that particular action.
- Red light: indicates the function "go back to the previous menu" if associated with the "DOOR" key. Indicates the function "delete the characters typed" if associated with the "P+" key.
- Green light: indicates confirmation of the action.

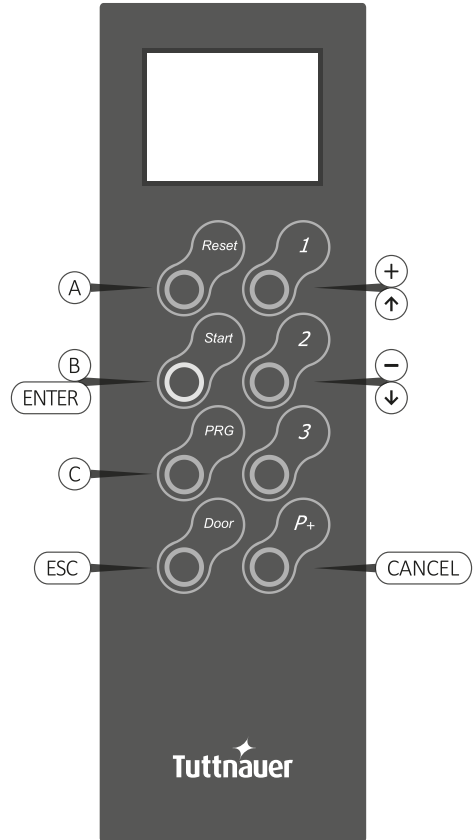

Fig. 16



On any screen and for any action you can only use the illuminated keys.

6.6 DISPLAY

The LCD display shows the status of the machine. The images show the various phases and the current operation. For example, if the machine is loading water, the display will show the image of the tap, of the water flow meter and of the water being loaded: if water is purified droplets will be light blue, if water is cold droplets will be blue and if water is hot they will be red. The temperatures are set in degrees Celsius or Fahrenheit. The images are animated, to show how the current operation evolves.

Description of the display (Fig. 17):

- 1) The number of the running program is displayed (e.g. P02 = program 2);
- 2) It displays the phase the machine is running. If the machine is going to run a wash cycle it will display the writing «Washing». When the machine displays an alarm that space background turns red and the message shows the number of the alarm and a brief description;
- 3) The AO value is displayed during disinfection;
- 4) Several animated images showing the current status of the machine are displayed;
- 5) The elapsed phase time from the moment the temperature set for the phase (see 12) has been reached is displayed;
- 6) Bar indicating the progress of the program; if the program is ending, the bar will be almost entirely green;
- 7) The temperature measured by the PT1000 probe, placed after the air heater, is displayed to indicate the temperature of the air entering the chamber;
- 8) It displays the temperature measured by the PT1000 probe placed in the tank. This is a control probe;
- 9) It is the display of the temperature measured by the PT1000 probe placed in the tank. This is a work probe. The temperature detectable by the two probes (control and work) must not differ from each other by more than 2°C;
- 10) Time for which the device should maintain the set temperature (see 12);
- 11) Phase of the program;
- 12) Temperature set for the current phase;
- 13) Date and time is displayed with the machine in stand-by.

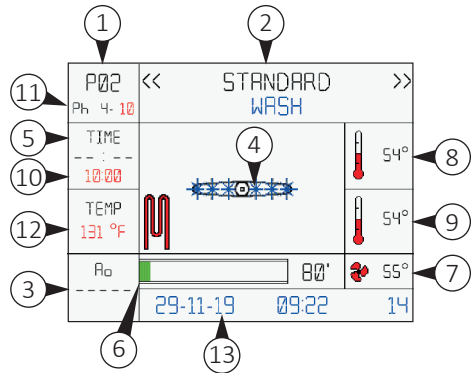

Fig. 17

6.6.1 MESSAGES ON THE DISPLAY

During washing, several messages may be displayed:

- Product 1 liquid reserve (meaning that the liquid inside the product 1 tank is finished and must be replaced);
- Product 2 liquid reserve (meaning that the liquid inside the product 2 tank is finished and must be replaced);
- Product 3 liquid reserve (meaning that the liquid inside the product 3 tank is finished and must be replaced).

These alerts are alternated with the description of the current phase.

When the cycle has finished the following message appears: «Program ended».

If the program is interrupted for one of the following reasons:

- when the Reset button is pressed,
- because of an alarm,
- power supply failure,

the display will show the message «Program interrupted no disinfection» (the words «no disinfection» only appear if the running program has not yet completed it).

The central part of the display also shows the message: «In 10 seconds the program will resume its operation or press and hold the reset button for 10 seconds to definitively stop it».

If the RESET button is pressed for 10 seconds, the program stops.



If the RESET button is not pressed, after 10 seconds the machine resumes the program previously interrupted.

➔ *If an alarm occurs, the machine stops until the problem is solved.*

6.6.2 DISPLAY SCREENS

After starting the machine, following the instructions in chapter «6.4 Starting the machine», the display will show the images indicating step-by-step the operations in progress.

- 1) Once the machine has started, the display shows the screen indicating door open and the invitation to insert the basket with the instruments to be washed. Then insert the basket with the instruments and close the door.

➔ **WARNING:** *The door must be tightly closed until you hear the classic closing «click», otherwise the program will not start.*

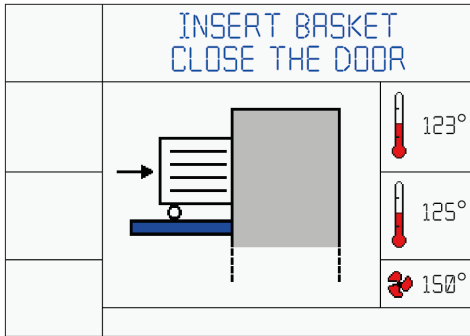

Fig. 18.1

- 2) With the machine started and door closed, the screen for selecting the programs will appear. Press the selected key (1 or 2 or 3 Fig. 12) on the control panel. To access subsequent programs (if stored), press the key «P+» several times.

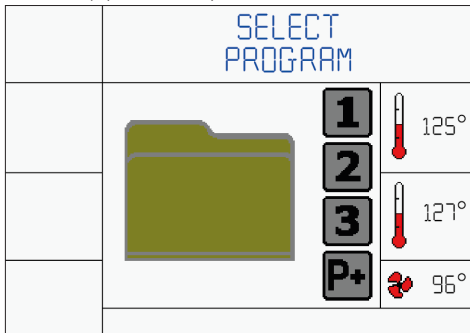

Fig. 18.2

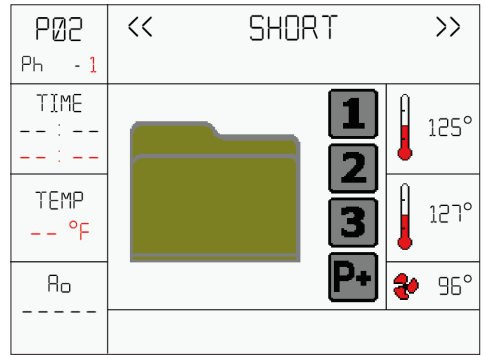

Fig. 18.3

- 3) Once the program is selected, the screen for selecting the user will appear. Press the key 1 or 2 on the control panel to navigate upward and forward in the user list. Then press START.

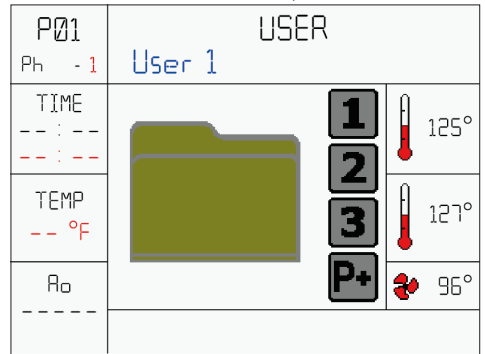

Fig. 18.4

- 4) Enter the password: use the key 1,2,3,A,B and C on the control panel to digit the correct password (See Fig. 16 for key description).

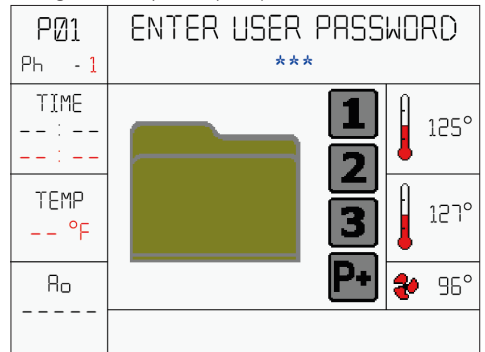

Fig. 18.5

6.6.3 PROGRAM 2 STANDARD

Phase 1

5) The machine starts the automatic work cycle and discharges any residual water present in the tank.

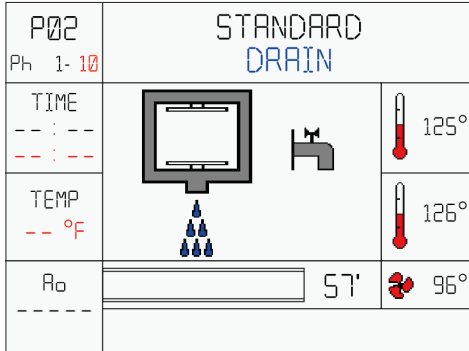

Fig. 18.6

Phase 2

6) Self-loading of cold water. During the self-loading phase, the tank will be filled with 1,6 US gal (6 l).

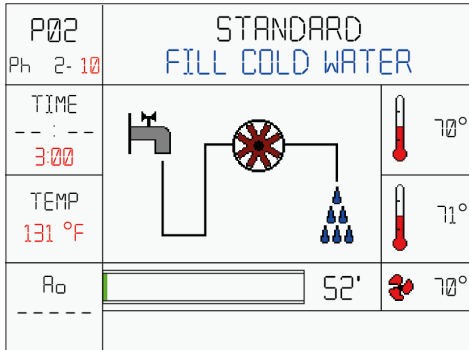

Fig. 18.7

7) Prewash phase begins.

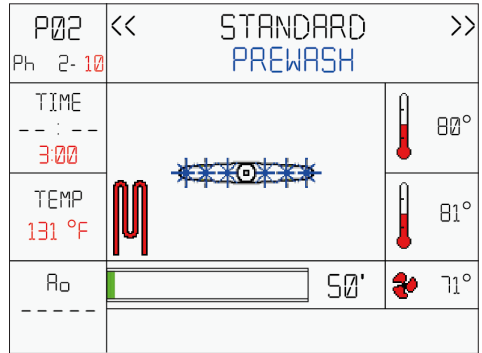

Fig. 18.8

Phase 3

8) At the end of the prewash phase, the water is automatically discharged.

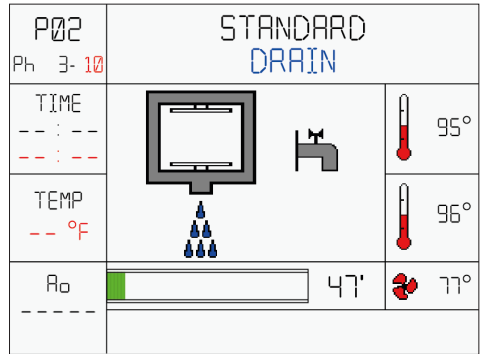

Fig. 18.9

Phase 4

9) Self-loading of cold water. During the self-loading phase, the tank will be filled with 1,6 US gal (6 l).

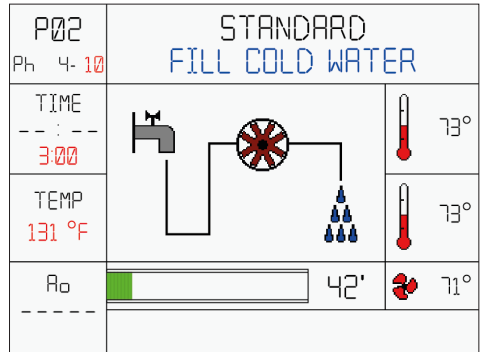

Fig. 18.10

10) Wash phase begins: the machine will rise the water temperature to the preset value and will keep it for the preset time.

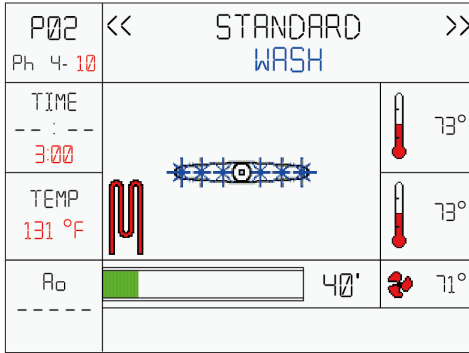

Fig. 18.11

11) When the water reaches the 95°F (35°C), the peristaltic pump 1 will dose the detergent.

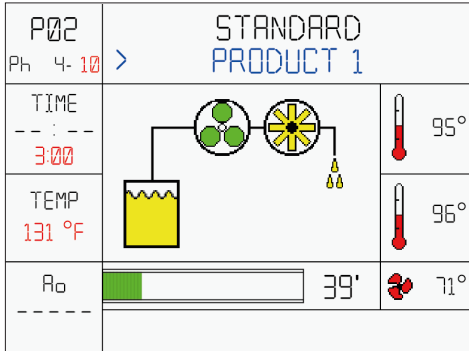

Fig. 18.12

Phase 5

12) At the end of the wash phase, the water is automatically discharged.

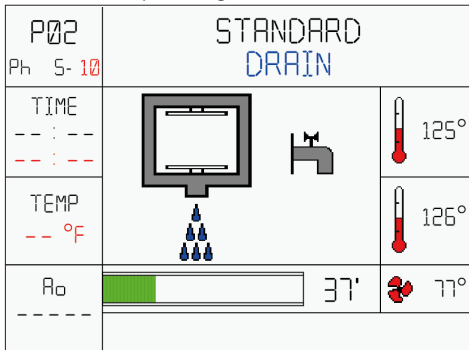

Fig. 18.13

Phase 6

13) Self-loading of purified water. During the self-loading phase, the tank will be filled with 1,6 US gal (6 l).

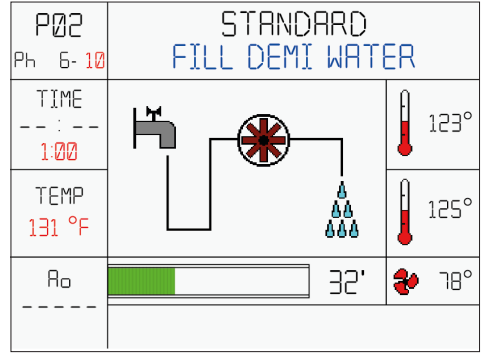

Fig. 18.14

14) Rinse phase begins: the machine will rise the water temperature to the preset value and will keep it for the preset time.

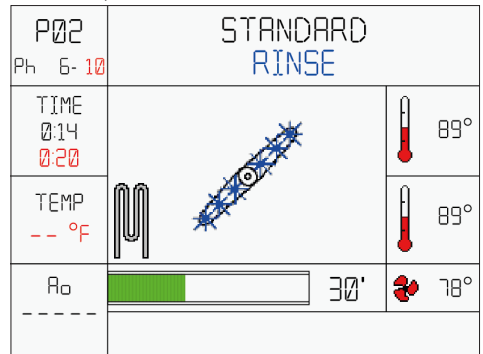

Fig. 18.15

15) When the water reaches the 104°F (40°C), the peristaltic pump 2 will dose the neutralizing agent.

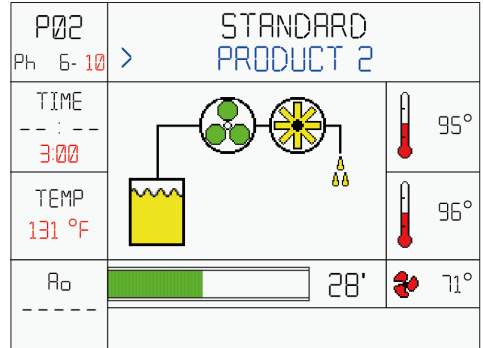

Fig. 18.16

Phase 7

16) At the end of the rinse phase, the water is automatically discharged.

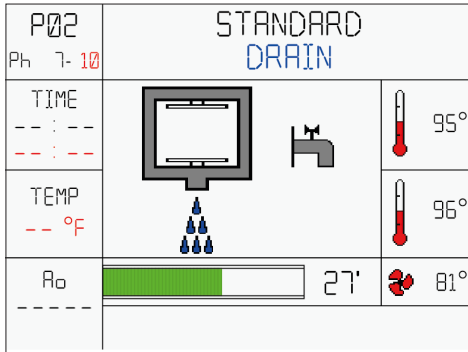

Fig. 18.17

Phase 8

17) Self-loading of purified water. During the self-loading phase, the tank will be filled with 1,6 US gal (6 l).

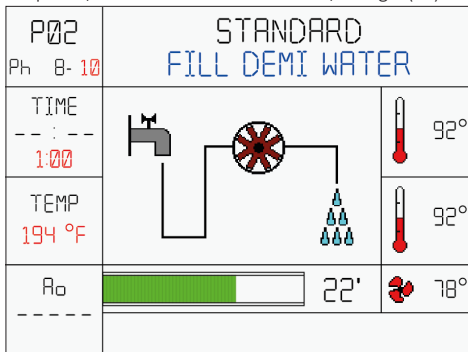

Fig. 18.18

18) Rinse phase begins: the machine will rinse the instruments while checking the conductivity of the water. At the end of the phase, if the conductivity will be below a presetted value, the machine will proceed to the next phase. If the check is negative, the machine will repeat phases 7 and 8 again. If the second check will fail, the machine will show an error and stop the cycle.

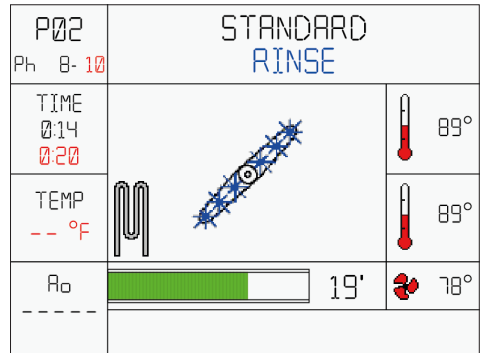

Fig. 18.19

19) Disinfection phase begins: the machine will rise the water temperature to 194° F (90° C) and will keep it for 5 minutes.

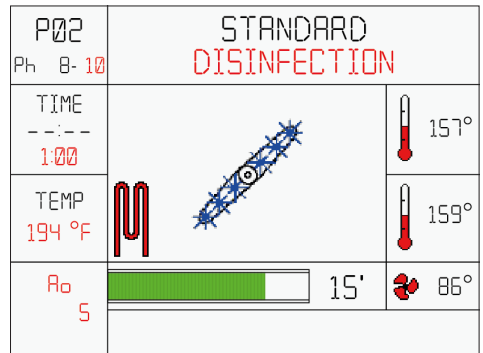

Fig. 18.20

Phase 9

20) At the end of the disinfection phase, the water is automatically discharged.

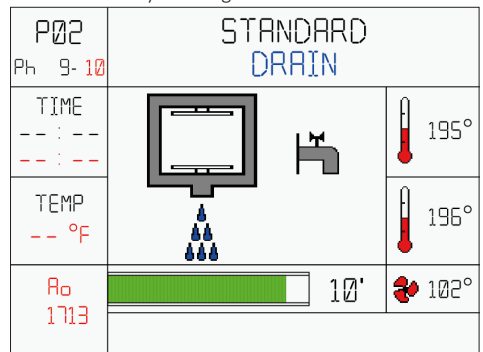

Fig. 18.21

Phase 10

21) Dry phase begins: hot air is blown inside the tank at a preset temperature and keep for the preset time. Phase not present in the version without drying.

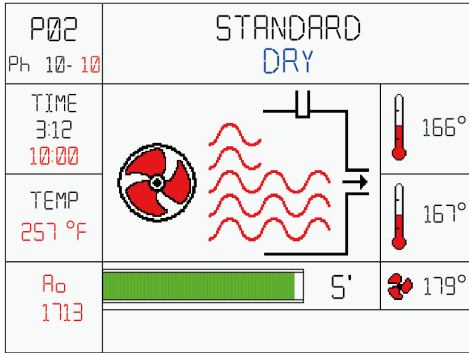

Fig. 18.22

22) End of the «STANDARD» cycle. Open the door and remove the basket.

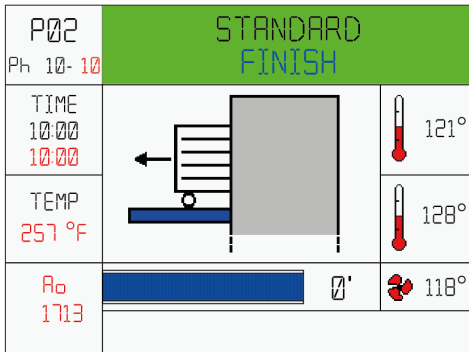

Fig. 18.23

If, for any reason, it is necessary to interrupt the cycle, simply hold down the RESET key for a few seconds until an audible alarm (buzzer) is heard and an alarm screen appears on the display with the message: «**WARNING. DISINFECTION CYCLE INTERRUPTED.**».

Once the problem is resolved, resume the cycle from the beginning. If the problem cannot be solved, contact the technical assistance.

6.6.4 ALARM MESSAGES

The machine is equipped with an alarm system that indicates malfunctions detectable with an audible signal (buzzer), a screen on the graphic display of the control panel and a red led light in the camber.

The alarms, description and possible solution are listed below.

At first the image concerning the alarm is displayed (for 5 seconds); then the alarm description is displayed (for 10 seconds).

The image and text alternate until the alarm is reset.

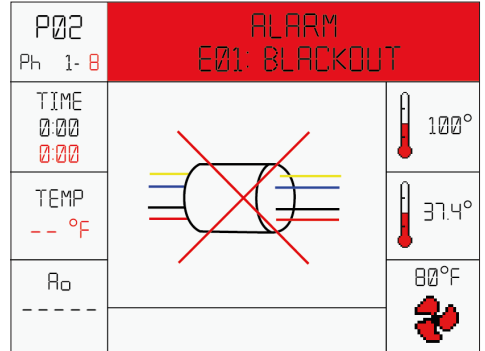

Fig. 19

6.6.5 USER SETTINGS MENU

Start screen

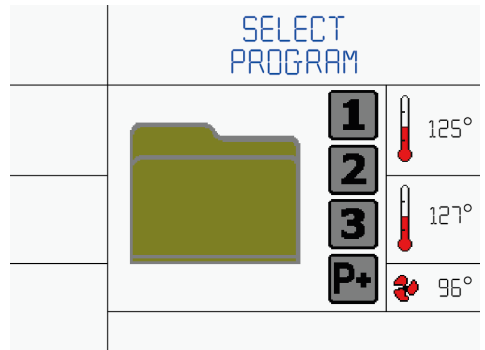

Fig. 20.1

To access the settings menu the procedure is as follows: Open door -> PRG for 5 seconds-> Insert password.

The keys and their operation are shown below, contextualised according the menu in which you are located:

- Use P1 and P2 to navigate up and down the menu.
- Press START to access the entry of the menu selected.

- Within the parameter, use the P1 and P2 keys to change the value of the highlighted parameter.
- Press START to go to the next parameter.
- Press PRG to return to the previous menu.

PROGRAMMING			
Insert password			170°
**			161°
			118°
10-10-19	09:48		67

Fig. 20.2

The menu consists of two screens, the item, when selected, lights up:

SETTINGS			
GENERAL			170°
TEMPERATURES			161°
TIMES			161°
PUMPS			118°
REGENERATION			
CONDUCTIVITY PROBE			
DRAIN PUMP			
PROBES CALIBRATION			
CLOCK			
CHEMICAL CALIBRATION			
10-10-19	09:49		67

Fig. 20.3

SETTINGS			
CYCLES COUNTER			170°
USER PIN			161°
MAINTENANCE			161°
VALIDATION			118°
DEFAULT			
PRINT LAST CYCLE			
10-10-19	09:50		67

Fig. 20.4

6.6.6 SETTINGS

See Annex 9.4 - 9.5.

6.6.7 LANGUAGE SETUP

To change the display language, with the door open, press PRG for 5 seconds and enter the Super User password. Once the menu appears, press the START button under GENERAL. Scroll to the “Display Language” setting and select the desired language from those available: 1=IT, 2=EN, 3=DEU, 4=FR, 5=SP, 6=POR, 7=SW.

6.6.8 USB KEY MANAGEMENT:

When the USB key is plugged in the machine, the following message appears after a few seconds:

P01	SAVING DATA		
Ph -1	Wait ...		46%
TIME		1	170°
---		2	
---		3	160°
TEMP		P+	118°

A0			

Fig. 21.1

When the USB key is removed from the machine, after a few seconds the following message appears.

USB KEY -> OFF			
		1	170°
		2	
		3	160°
		P+	118°
10-10-19	14:46		67

Fig. 21.2

6.6.9 PROCEDURE FOR PASSWORD CHANGE

To generate the password use the keys 1,2,3,A,B and C (See Fig. 16 for key description). Entering the password incorrectly three times in a row will cause the block of the user.

See Annex 9.6.

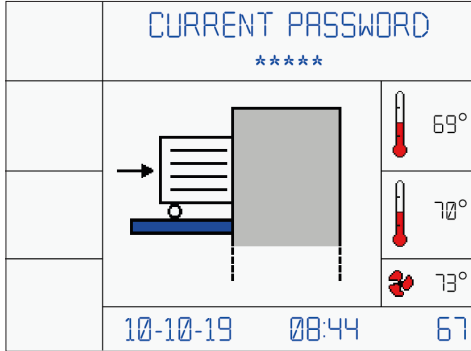

Fig. 22

6.6.10 EXPIRING PASSWORDS

- User password: has a preset validity of 6 months, at the end of the expiring date, it must be renewed. At first access it must be generated by the Super User. See Annex 9.6 for the procedure for password change. See Annex 9.7 for the procedure for user password setup for the Super User.

- Super User password: at the first access enter the password "111111". As for the User, the Super User password has a validity of 6 months, after that it must be renewed.

See Annex 9.8.

6.7 ALARMS

See Annex 9.9.

6.8 WARNINGS

See Annex 9.10.

7 SOFTWARE DESKTOP

7.1 GENERAL INFORMATIONS

The device comes with a desktop software, called "WasherRePortal", that gives enhanced features to the User. With this software, in fact, it's possible to:

- create and print digital versions of the reports;
- connect the device to the PC to customize the user names and passwords via USB port (cable not included);
- save the information coming from multiple devices;
- import and export the database of reports;

- export comma separated value files (*.CSV) for post-processing activities (free files editables with third-part softwares like MS Excel).

For all information visit the web portal www.tuttnauerusa.com.

7.2 FIRST ACCESS LOGIN

At the first access use these login information:

- User: user name "user" and password "123456".
- Admin: user name "admin" and password "123456".



It is recommended, for the Admin, to change the passwords at the first access, according to the company policy rules.

7.3 FIRST LOGIN

To access to the software, insert the user and password inside the text boxes as below:

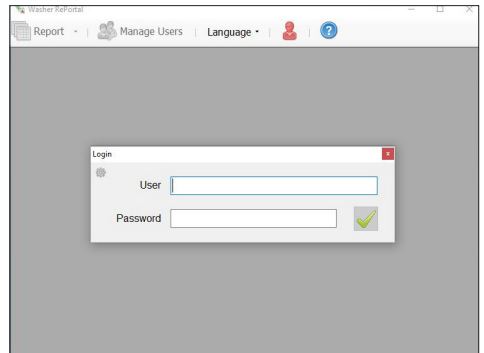

Fig. 23.1

7.3.1 PASSWORD CHANGE

To change the name and password of the admin or the user, from the admin login, enter in the admin menu and click "Change Password".

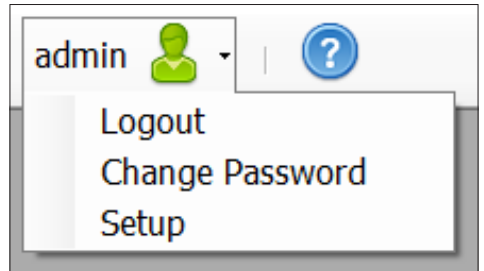

Fig. 23.2

A change password window will appear, enter the name and password and click the green check to confirm the

change.

The changes will be available from the next login, see image below:

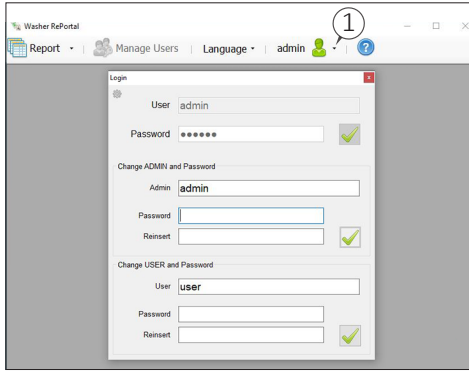

Fig. 23.3

7.4 CABLE CONNECTION TO THE DEVICE

To customize user names and passwords, connect with the PC to the device with a USB cable (not included), by using the USB connection of the device (See 3 Fig. 13a). From the Admin login, click on "Manage User" (1 Fig. 23.4). If it doesn't work, close and restart WasherRePortal.



The passwords can contain only these characters: 1,2,3,A,B and C (See chapter 6.5 and 6.6.8).

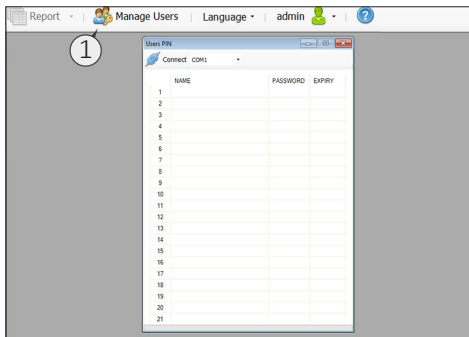

Fig. 23.4

7.5 WORKING FOLDER SETUP

To customize the working folder, from the Admin login, enter in the admin menu and click "Setup" (See Fig.23.2). Choose:

- the "Database Archive Folder" by pressing the button 1;

- the preset "PDF certificate Archive Folder" by pressing the button 2.

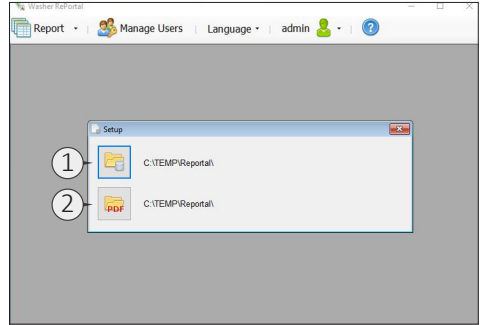

Fig. 23.5

7.6 DATA IMPORT

To import the data from the USB key, previously connected to the device in the USB port (2 Fig. 13a), and display the Report data, connect the USB key to the PC, click on the "Report" menu item (1 Fig. 23.6a) and proceed with the USB import, see image below:

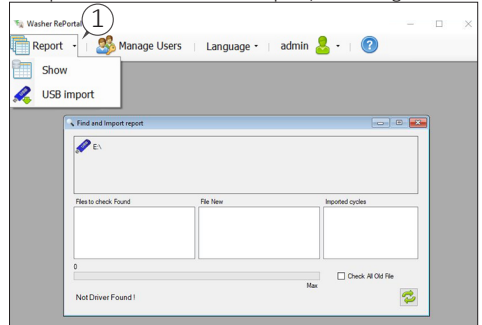

Fig. 23.6a

The process will import all the data stored in the USB key, at the end of the process, close the import window.

7.7 DATA VISUALIZATION

Click on the "Report" menu item (1 Fig. 23.6a) and proceed with the "Show" item.

A new window will appear showing the data, divided by machine serial number. On clicking to each serial number, there will be full access to the reports, divided by year and month.

7.7.1 ADMIN AVAILABLE FEATURES

Right-clicking over the serial number or year (1 Fig. 23.6b) opens a drop-down menu that allows to choose between:

- Delete DB: delete the entire database or only the selected item (Fig. 23.6c);
- Export DB: export the entire database on a specified folder;
- Import DB: import the entire database from a specified file.

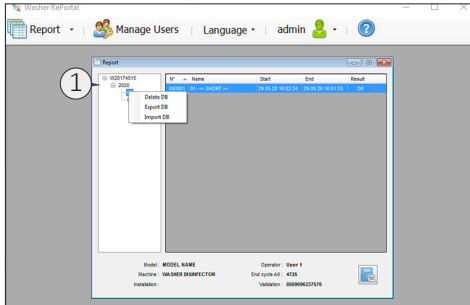

Fig. 23.6b

Delete DB features

The "Delete DB" function permit to delete the full database, by clicking "yes" at the first choice (1 Fig. 23.6c), or delete the single machine's serial number by clicking "yes" at the second choice (3 Fig. 23.6c).

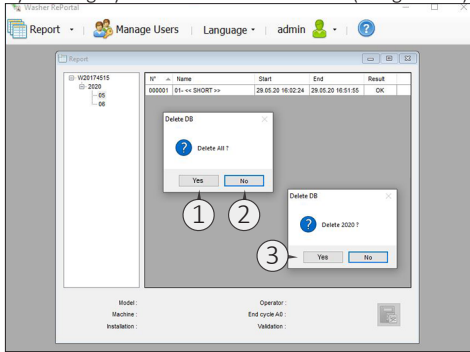

Fig. 23.6c

7.7.2 USER AVAILABLE FEATURES

Right-clicking over a report number (Fig. 23.6d) opens a drop-down menu that allows to choose between:

- Full CSV: export an editable CSV file in a specified folder with all the informations of the Report;
- Graphic CSV: export an editable CSV file in a specified folder with the graph data;
- Phases CSV: export an editable CSV file in a specified folder with the phases data.

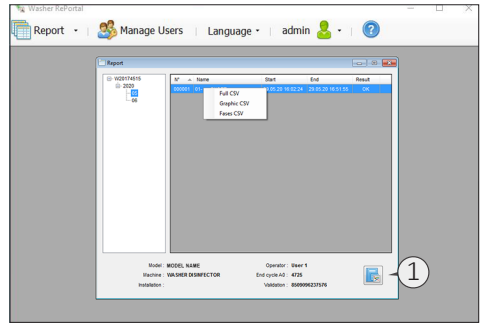

Fig. 23.6d

7.7.3 REPORT VISUALIZATION

By clicking of the button (1 Fig. 23.6d), or by double clicking over a single report name, it's possible to create a PDF certificate file and save it in the specified folder declared in 7.5.

To generate the PDF file click on button 1 Fig. 23.6e.

To find and open the generated file, click on button 2 Fig. 23.6e.

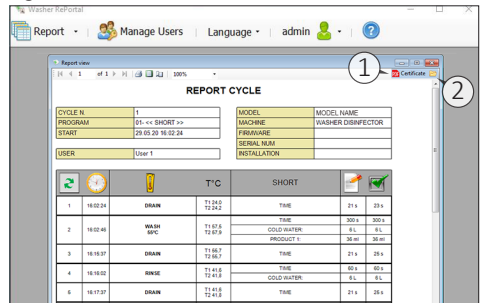

Fig. 23.6e

7.8 PASSWORD RESET

7.8.1 USER LOGIN DATA LOST

Contact your administrator.

7.8.2 ADMIN LOGIN DATA LOST

In case of admin login data lost, type a random user and password, then, click on the gear icon (1 Fig. 23.7).

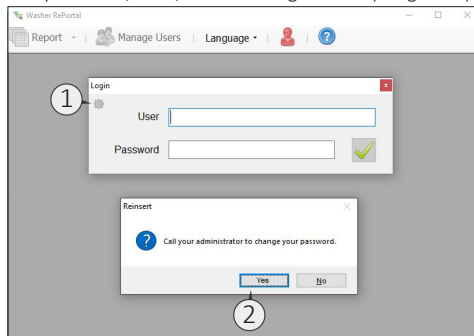

Fig. 23.7

Click "Yes" (2 Fig. 23.7), a new window will appear showing the Reset ID (1 Fig.23.8): without closing the screen, contact the customer care to retrieve the reset code.

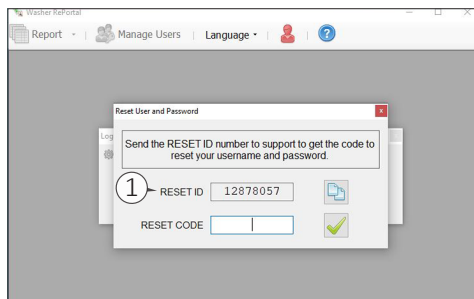

Fig. 23.8

At the end of the process, the User and Admin passwords will be resetted to the presettings (See chapter 7.2).

8 MAINTENANCE

8.1 GENERAL INFORMATION

Maintenance is a set of periodic and predefined operations aimed at maintaining the machine functionality in all its aspects as a result of intrinsic wear and use.

The routine maintenance operations are described below. It should be remembered that the lower operating cost and a long life of the machine depend on the continuous observance of what is reported in this manual.



For special maintenance operations, not included in this manual, contact the manufacturer.



The thermodisinfector maintenance operations must be carried out with the machine completely switched off.



If the machine is not used for more than 24 hours it is necessary to run a standard cleaning program, without any instruments inside.

The operator engaged in this type of intervention must wear PPE (Personal Protective Equipment) and must be sure that no other unauthorised person is present in the operating area of the machine. Before maintenance, start a program to disinfect the washing tank.

Maintenance request

After a certain time or a certain number of operating hours, the display shows «MAINTENANCE». This signal has no influence on the machine operation.

8.1.1 ROUTINE MAINTENANCE

Routine maintenance includes all those jobs needed to keep the machine clean and functioning. These jobs must be carried out regularly or when necessary and the user is responsible for verifying their regularity.

Daily

- Regularly check the filling status of containers before starting the program.
- Clean the tank.
- Clean the wash tank filters.
- Clean the external panels with a damp cloth. Use only neutral pH detergents. Do not use aggressive products, solvents and/or diluents.
- Clean the control panel with a damp cloth and washing up liquid. Do not use aggressive products, solvents and/or diluents.

- Clean the wash tank filters.

Weekly

- Check the rotary movement of the spray arms.
- Open the panels and rinse the inside.
- Check the nozzles and clean them.



Fig. 24.1

Filter unit: 1) Central filter. - 2) Mesh filter. - 3) Tank bottom filter. - 4) Salt tank cap.



WARNING. Do not spray the machine or near it with water jets, or with pressure devices.

Proceed as follows to clean the filters in the wash tank:

- Open the door and remove the load basket.



Warning: Very hot surfaces.



Risk of injury: Be careful with sharp and pointed objects, which are withheld in the baskets.

- Remove the central filter (1 Fig. 22.1).
- Remove the mesh filter (2 Fig. 22.1).
- Remove the tank bottom filter (3 Fig. 22.1).
- Carefully clean the filters and remove the residual substances.
- Remove the deposits from the drain and clean the drain.

At the end of the cleaning operations, refit the filters in succession.

Clean the spray arms as follows:

- Open the door and remove the load supports.



Warning: Very hot surfaces.

- Using the tools provided, loosen and remove both spray arms.
- Rinse the spray arms thoroughly.
- Reassemble and tighten in position.
- Reassemble the spray arms.

8.1.2 SPECIAL MAINTENANCE

Special maintenance operations are not foreseen by the user but must be performed exclusively by the technical assistance or by an authorised and qualified technician.

Scheduled maintenance operations must be carried out every 1000 hours of operation or every 12 months.

- Check the electrical safety according to VDE 0701/0702.

- Check the filter in the water supply valves.
- Check the dosing systems.
- Check the thermostat sensor, thermoelectric measurements.

- Check the conditions and functionality of the spray arms.

- Check the safety thermostat.
- Check the seal of the door.
- Check the steam condenser.
- Check the functionality of the drain pump.
- Check the pressure switch.
- Check the drain pipes.
- Check the water supply pipes.
- Check for any leaks.
- Check the fixing of the door lock in regard to the door seals.
- Replace the prefilter.
- Replace the HEPA filter.

8.1.3 AIR SUCTION FILTER

The thermodisinfector is standard equipped with a suction filter for drying air (Fig. 22.2), to be replaced after about 100 hours of work (equal to about 100 cycles).

The machine can also be equipped with an «absolute» «HEPA H14» class supplementary air filter (on request), in compliance with EN 1822. We recommend replacing the HEPA filter every 500 working hours, which is equivalent to about 1000 operating cycles.



Fig. 24.2

8.2 TROUBLESHOOTING

The table (Annex 9.10) lists the main malfunctions, with relative causes and recommended solutions, that the machine may present during its operation.

The interventions that may become necessary must be carried out by experienced and qualified operators.

If the problems persist or appear even more often after performing the work reported below, contact the technical assistance or an authorised and qualified technician.

See Annex 9.11.

8.3 EQUIPMENT DISPOSAL



Respect the laws in force in the country of use of the machine, in relation to the use and disposal of the products used for the cleaning and maintenance of the machine, as well as observe what the manufacturer of these products recommends.

When disposing of a thermosinfector, it is necessary to remember that it can still be contaminated by blood and other organic liquids, pathogenic germs, genetically modified material, toxic or carcinogenic substances, heavy metals, etc. and, therefore, it must be decontaminated before its disposal.

For safety and environmental protection reasons, dispose of all chemical residues in compliance with applicable legislation. When performing this operation, use protective goggles and gloves. Remove or disengage the door lock so that no one can get closed inside the machine, e.g. children playing. Finally, deliver the

machine to a suitable and authorised collection centre. The electrical and electronic devices to be disposed of contain reusable materials.

They also contain components harmful for the environment, but necessary for the correct operation and safety of the equipment. If they are not disposed of correctly or are disposed of as household waste, these components can damage human health and the environment. Never dispose of the old thermosinfector among conventional waste.

Unauthorised product disposal by the user entails the application of very strict administrative sanctions provided for by current legislation. Enquire about this at your local dealer. Depending on the country in which one resides and the regulations in force, one is obliged to delete the data referring to people and stored on the machine.

Finally, make sure that the old equipment is kept out of reach of children until its actual disposal.

8.4 SPARE PARTS

The various components of the machine can be requested directly to the manufacturer by providing the following data:

- **Model, serial number and year of construction of the machine.** These data are stamped on the identification plate fitted on each individual machine.
- **Description of the part and required quantity.**
- **Shipping method.** If this item is not specified, the manufacturer, although dedicating particular care to this service, is not liable for any shipping delays due to force majeure. Shipping costs are always charged to the recipient. Goods travel at the risk and danger of the customer, even if sold carriage free.

Finally, please note that the manufacturer is always available for any assistance and/or spare parts.

See Annex 9.12.

9 ANNEXES

9.1 INSTALLATION SCHEME FOR CT

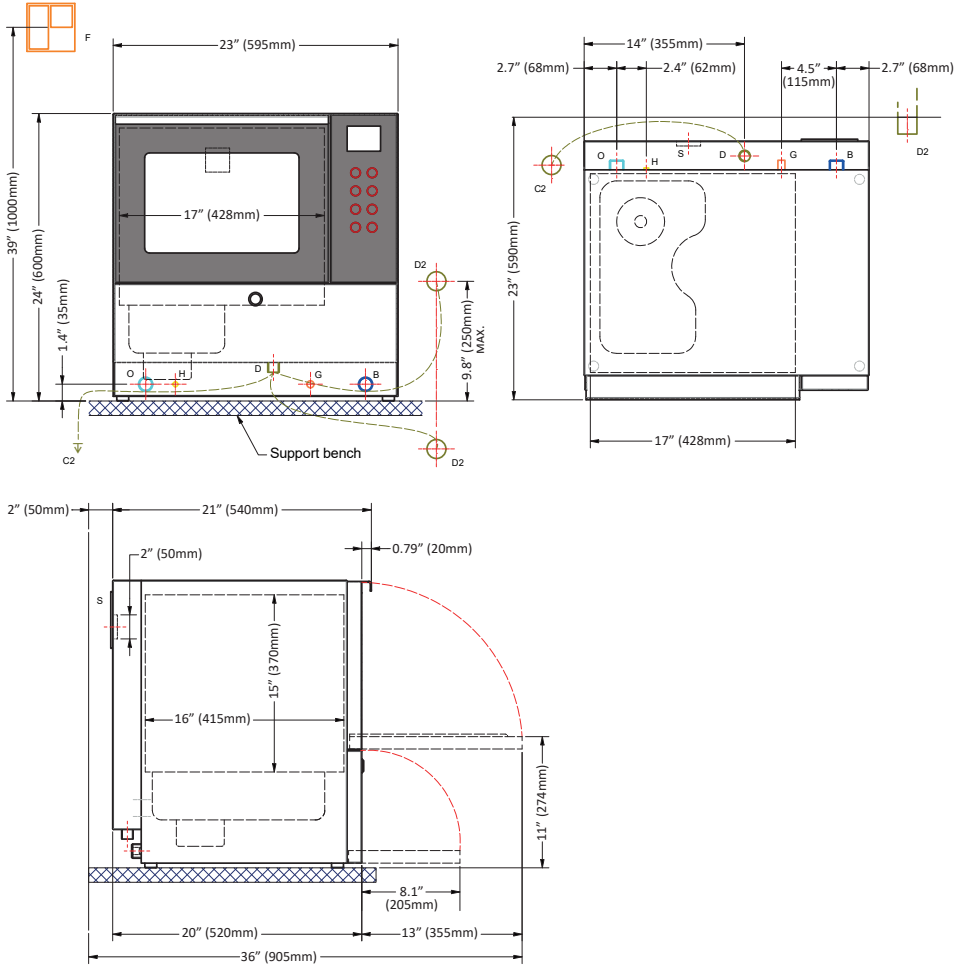

LEGEND

Pos.	Description
B	COLD WATER CONNECTION - 3/4"G (TUBE 1/2"G)
C2	DRAIN DN40 - HOSE CONNECTION 25MM (AT FLOOR)
D	DRAIN CONNECTION TO THE MACHINE
D2	DRAIN DN40 - HOSE CONNECTION 25MM (AT WALL)
F	OMNIPOLAR MAGNETO SWITCH WITH A CIRCUIT BREAKER
G	ELECTRICAL CONNECTION BOX
H	EQUIPOTENTIAL CLAMP
O	DEMINERALIZED WATER CONNECTION 3/4"G-M (TUBE 1/2"G)
S	STEAM BREATHER

9.2 INSTALLATION SCHEME FOR UC

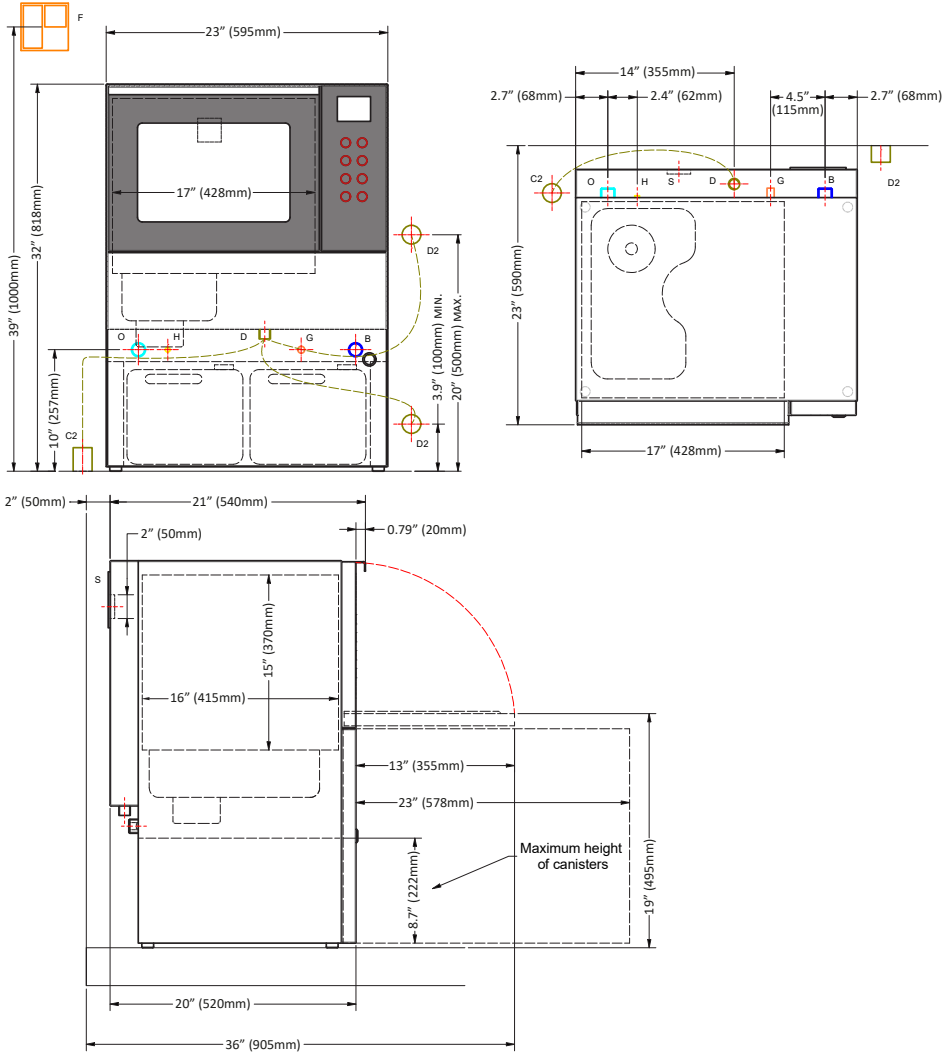

LEGEND

Pos.	Description
B	COLD WATER CONNECTION - 3/4" G (TUBE 1/2" G)
C2	DRAIN DN40 - HOSE CONNECTION 25MM (AT FLOOR)
D	DRAIN CONNECTION TO THE MACHINE
D2	DRAIN DN40 - HOSE CONNECTION 25MM (AT WALL)
F	OMNIPOLAR MAGNETO SWITCH WITH A CIRCUIT BREAKER
G	ELECTRICAL CONNECTION BOX
H	EQUIPOTENTIAL CLAMP
O	DEMINERALIZED WATER CONNECTION 3/4" G-M (TUBE 1/2" G)
S	STEAM BREATHER

9.3 PROGRAMS DETAILS

Program	Prewashing	Washing	Rinsing	Rinsing	Thermodis.	Drying
	WATER TEMP-TIME CHEMICAL	WATER TEMP-TIME CHEMICAL	WATER TEMP-TIME CHEMICAL	WATER TEMP-TIME CHEMICAL	WATER TEMP-TIME CHEMICAL	TEMPERATURE TIME
Program 1 SHORT	COLD 180 s	WARM 55°C- 600 s ALK.- 5‰	DEMI 40°C- 120 s ACD.- 1‰	DEMI 120 s µS check	DEMI 90°C- 300 s	125°C 600 s
Program 2 STANDARD	COLD 240 s	WARM 55°C- 600 s ALK.- 6,5‰	DEMI 45°C- 180 s ACD.- 1,5‰	DEMI 120 s µS check	DEMI 90°C- 300 s	125°C 1200 s
Program 3 INTENSIVE	COLD 300 s	DEMI 60°C- 600 s ALK.- 8‰	DEMI 55°C- 240 s ACD.- 2‰	DEMI 120 s µS check	DEMI 90°C- 300 s	125°C 1440 s
Program 4 RINSING	COLD 60 s	-	-	-	-	-
Program 5 DRYING	-	-	-	-	-	125°C 600 s

9.4 MENU PARAMETER TABLE

ID	Parameter Name	Min	Max	Description	Factory Default
GENERAL					
1	Unloading user PIN	0=OFF	1=ON	Enables or disables automatic door unlock at the end of the cycle.	OFF
2	PIN expiration month	1	99	Set password expiration time	1
3	Font Display	0=EUR-JAP	1=EUR-CYR	Sets the font map to European / Japanese or European / Cyrillic.	EUR-JAP
4	Display language	1	8	Selects the desired language for the display.	ENGLISH
5	Printer language	1	8	Selects the desired language for the printer..	ENGLISH
6	Temperatures [0=°C 1=°F]	0=°C	1=°F		°C
REGENERATION					
7	Water hardness (°fH)	0	60	French degrees of water	0
CLOCK					
8	Date and Time	DW DD/MM/YY HH:MM:SS		Sets current date and time.	
CYCLES COUNTER					
9	Total Cycles	Number of machine life cycles.			
10	Program cycles 1	Number of cycles performed with program 1.			
11	Program cycles 2	Number of cycles performed with program 2.			
12	Program cycles 3	Number of cycles performed with program 3.			
13	...	Number of cycles performed with program.			
14	Program cycles 40	Number of cycles performed with program 40.			
USER PIN					
15	Pin User 1	To set the user password, press the RESET key and enter the 6 desired numbers using numbers 1, 2 and 3.			
16	Pin User 2				
17	...				
18	Pin User 20				
19	SuperUser				

9.5 MENU STRUCTURE

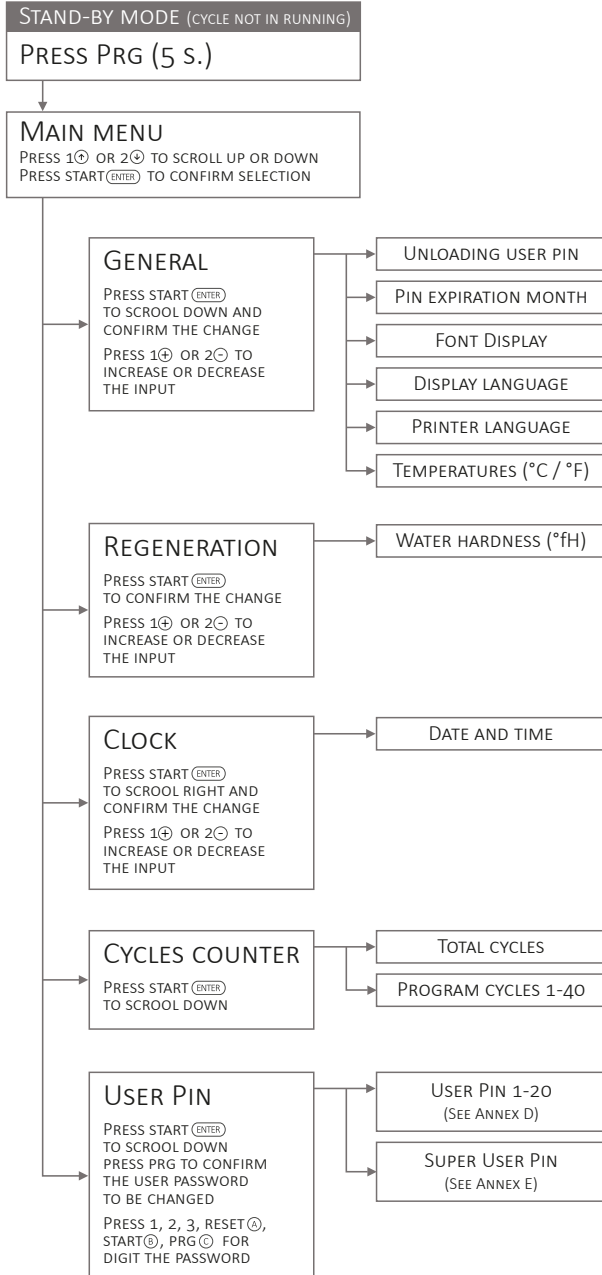

9.6 PROCEDURE FOR PASSWORD CHANGE

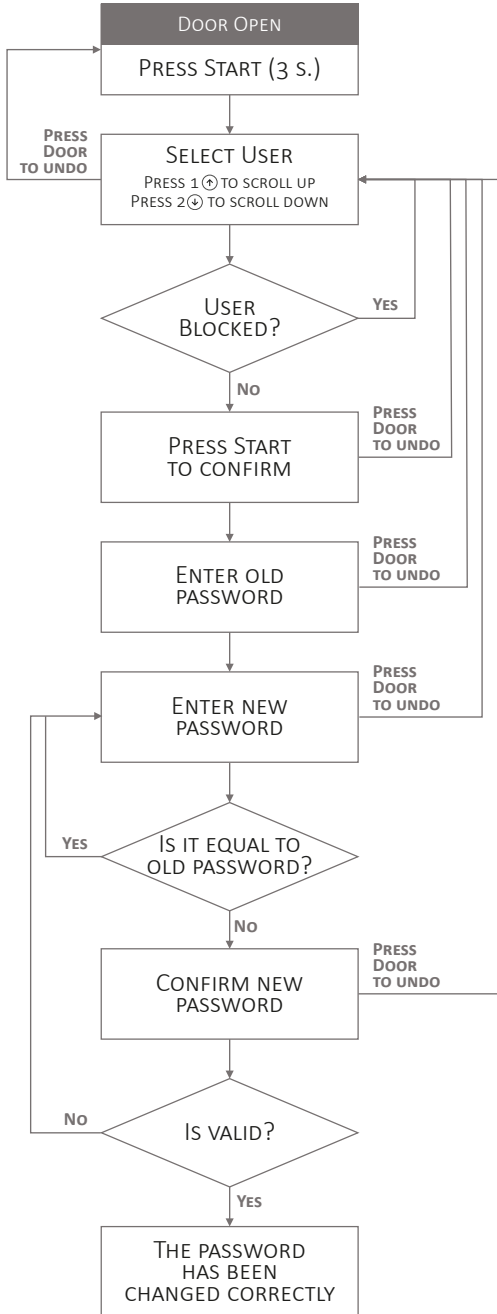

9.7 PROCEDURE FOR USER PASSWORD SETUP FOR THE SUPER USER

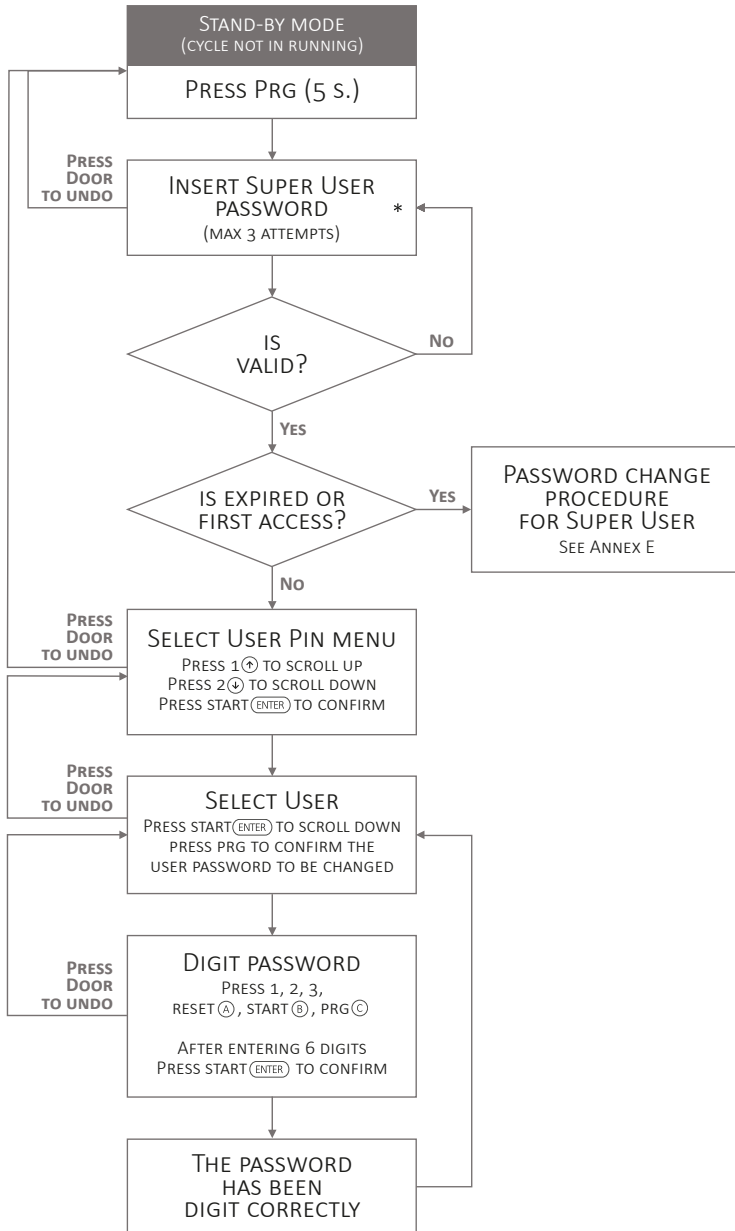

*At the first access enter: 111111

9.8 PROCEDURE FOR SUPER USER PASSWORD CHANGE

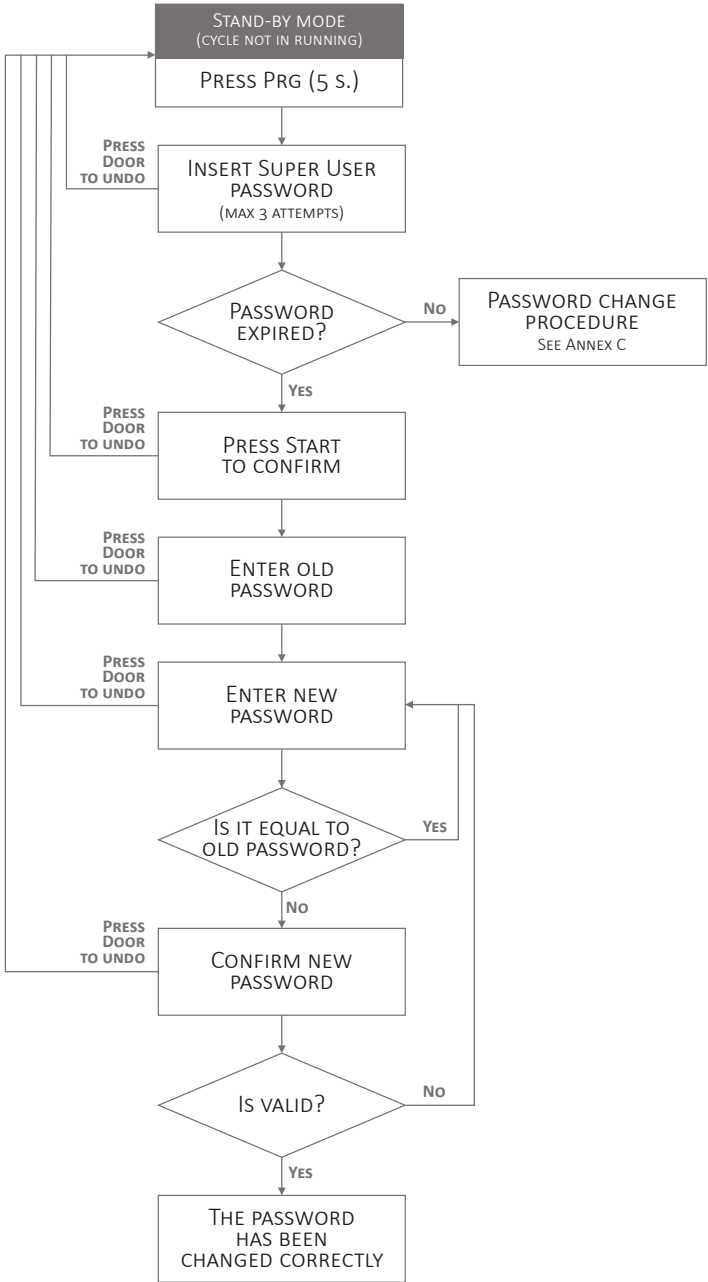

9.9 ALARM TABLE

ALARM	DESCRIPTION	ACTION
E00 EEPROM ALARM	Firmware installed successfully.	1- Press RESET 2- Install new dataset
E01 BLACKOUT	A blackout occurred during cycle execution and the program was stopped.	Press RESET
E02 DOOR OPEN	The door is open or unlocked. Close the door.	Press RESET If it persists, call the technician.
E07 NO LOCKED DOOR	The door did not lock within the set time.	Press RESET If it persists, call the technician.
E09 NO UNLOCKED DOOR	The door did not lock within the set time.	Press RESET If it persists, call the technician.
E11 DIRTY WATER	Check for dirt on the load and check the inlet demineralized water.	Press RESET If it persists, call the technician.
E20 NO COLD WATER	The cold water tap could be closed or partially open. Check it.	Press RESET If it persists, call the technician.
E21 NO HOT WATER	The hot water tap could be closed or partially open. Check it.	Press RESET If it persists, call the technician.
E22 NO DEMI WATER	The demineralized water tap could be closed or partially open. Check it.	Press RESET If it persists, call the technician.
E24 DRYING FAN	The drying fan might be malfunctioning, broken or disconnected.	Press RESET If it persists, call the technician.
E26 PRINTER ERROR	The printer is turned off, unplugged or out of paper. Check it.	Press RESET If it persists, call the technician.
E30 FLOWMETER 1	Chemical liquid tank 1 might be empty. Check it.	Press RESET If it persists, call the technician.
E31 FLOWMETER 2	Chemical liquid tank 2 might be empty. Check it.	Press RESET If it persists, call the technician.
E32 FLOWMETER 3	Chemical liquid tank 3 might be empty. Check it.	Press RESET If it persists, call the technician.
E34 PRODUCT TIMEOUT	The density of the chemical liquid might be too high. Check it.	Press RESET If it persists, call the technician.
E41 DRAIN TIMEOUT	The drain pipe might be blocked or clogged. Check it.	Press RESET If it persists, call the technician.
E43 DRY TEMPERATURE	The load might not be dried because the minimum set temperature has not been reached.	Press RESET If it persists, call the technician.
E44 PREWASH TEMPERAT	A too high temperature was detected during the prewash phase.	Press RESET If it persists, call the technician.
E45 CHAMBER T.LIMIT	A too high temperature was detected inside the chamber.	Press RESET If it persists, call the technician.
E46 AIR T.LIMIT	A too high air temperature was detected.	Press RESET If it persists, call the technician.
E47 PHASE T. LIMIT	A too high temperature was detected during the current phase.	Press RESET If it persists, call the technician.
E50 PROBE 1 BROKEN	Chamber probe PT1000-1 (work) might be broken or disconnected.	Press RESET If it persists, call the technician.

ALARM	DESCRIPTION	ACTION
E51 PROBE 2 BROKEN	Chamber probe PT1000-2 (control) might be broken or disconnected.	Press RESET If it persists, call the technician.
E52 AIR PROBE BROKEN	Air probe PT1000-3 might be broken or disconnected.	Press RESET If it persists, call the technician.
E53 CHAMBER T. DIFF	A temperature difference between the probes in the chamber has been detected too high.	Press RESET If it persists, call the technician.
E66 NO HEATING	There is a problem with water heating.	Press RESET If it persists, call the technician.
E67 CONDENSER LEVEL	The water inside the steam condenser has reached the maximum level allowed.	Press RESET If it persists, call the technician.
E70 PUMP PRESSURE	There could be water leaks.	Press RESET If it persists, call the technician.
E71 HEPA FILTER	The HEPA filter might be dirty or clogged. Check it.	Press RESET If it persists, call the technician.
E75 PRODUCT 1 EMPTY	Chemical liquid tank 1 is empty. Add liquid.	Press RESET If it persists, call the technician.
E76 PRODUCT 2 EMPTY	Chemical liquid tank 2 is empty. Add liquid.	Press RESET If it persists, call the technician.
E77 PRODUCT 3 EMPTY	Chemical liquid tank 3 is empty. Add liquid.	Press RESET If it persists, call the technician.
E80 SPRAY ARM LOCKED	The spray arm marked in red on display is locked. Remove it and clean.	Press RESET If it persists, call the technician.
E89 NO DISINFECTION	The minimum value of A0 was not reached and the load is still contaminated.	Press RESET If it persists, call the technician.

9.10 WARNINGS TABLE

WARNING TYPE	DESCRIPTION	ACTION
LIQUID RESERVE PRODUCT 1	Product 1 is in reserve or may be empty.	Add the product 1
LIQUID RESERVE PRODUCT 2	Product 2 is in reserve or may be empty.	Add the product 2
LIQUID RESERVE PRODUCT 3	Product 3 is in reserve or may be empty.	Add the product 3
REQUEST MAINTENANCE	Contact customer service or the dedicated technical assistance for periodic maintenance.	Press RESET
REQUEST VALIDATION	Contact customer service or the dedicated technical assistance for periodic validation.	Press RESET
REFILL SALT TANK	1- Take out the basket 2- Unscrew the cap of the salt tank 3- Fill the salt tank 4- Screw the cap of the salt tank	Press RESET For 5 seconds

9.11 TROUBLESHOOTING

PROBLEM	CAUSE	SOLUTION
1 The machine does not start	The fuse / circuit breaker of the electrical system has tripped.	Enable the fuse / switch of the electrical system.
	The machine is off.	Press the ON/OFF key.
2 The program does not start	Door not closed correctly.	Check door closure.
3 The program stops	No chemical products.	Turn off the machine and fill the containers.
	Water flow closed.	Open the water flow.
4 The operating temperature for the program is not reached	The thermostat sensor in the washing tank is covered with deposits.	Clean the thermostat sensor.
5 The machine does not dry	The air filter in the drying system is dirty or clogged.	Replace the filter. Have special maintenance performed by technical assistance.
6 White deposits in the washing tank	Softener finished due to lack of salt.	Add the salt for regeneration.

9.12 SPARE PARTS

ID	DESCRIPTION	QUANTITY
01	Micro-board	1
02	Display Board	1
03	Water Heater	2
04	Washing pump UL	1
05	Valve	1
06	Washing pressure switch	1
07	Drainage pump UL	1
08	Dryer blower	1
09	Air heater + insulation	1
10	HEPA filter vacuum switch	1
11	PT1000 probe for drying system	1
12	HEPA filter H14	1
13	Pre-filter	1
14	Condenser level probe	1
15	Single electro-valve	3
16	Double electro-valve	3
17	Flow regulator	2
18	Flow limiter	1
19	Flow meter	2
20	Water softner	1

ID	DESCRIPTION	QUANTITY
21	Flexible pipe for cold or demi water	2
22	Door lock	1
23	Chamber gasket	1
24	Door gasket	1
25	Door spring	1
26	Dosing pump	2
27	Chemical's flowmeter	3
28	Chemical tank	1
29	Supply power cord with plug 6-20P	1
30	Filter connector	1
31	PT1000 probe 1	1
32	PT1000 probe 2	1
33	Power supply	1
34	Relè	2
35	Contacteur	1
36	Fuse	10
37	Fuse	10
38	Fuse	10
39	Fuse	10
40	Fuse	10
41	Discharge pressure switch	1
42	Safety pressure switch	1
43	Cooling Fan	1
44	Discharge pipe	2
45	Spray arm cap	3
46	Spray arm spring	2
47	Flanged bush	4
48	Handpieces holder adapter	1
49	OR seal and cord	4
50	Basket clip for handpieces holder	2
51	Basket's corner foot	4
52	5x8 Viton tube	By the meter

9.13 FUSES

LITTLEFUSES - UL 248-14
F 2 A - 217 (5X20T)

LITTLEFUSES - UL 248-14
F 3.15 A - 217 (5X20T)

LITTLEFUSES - UL 248-14
F 2 A - 217 (5X20T)

LITTLEFUSES - UL 248-14
F 2 A - 217 (5X20T)

LITTLEFUSES - UL 248-14
F 2 A - 217 (5X20T)

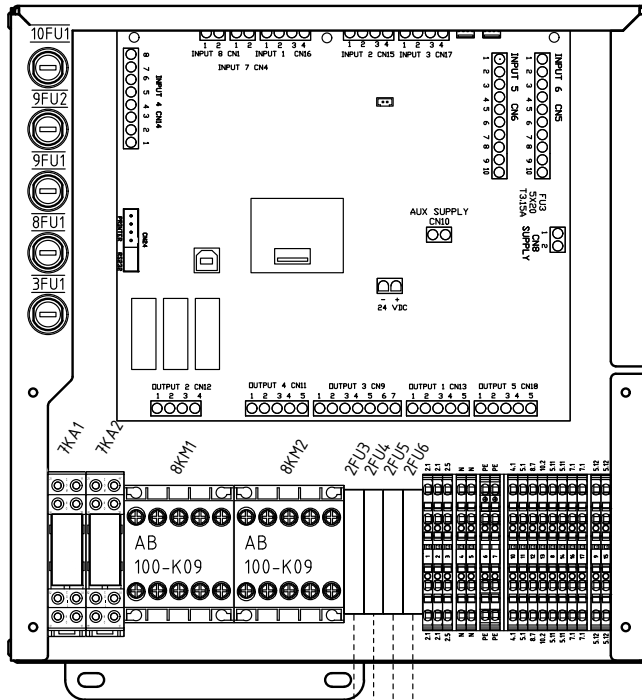

- LITTLEFUSES - UL 248-14
F 2 A - 217 (5X20T)
- BUSSMANN - UL 248-14
F 5 A - S500 (5X20T)
- ITALWEBER - UL 248-14
F 6.3 A - 51NM - 0444306 (5X20T)
- ITALWEBER - UL 248-14
F 6.3 A - 51NM - 0444306 (5X20T)

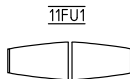

LITTLEFUSES - UL 248-14
F 500 mA - 217 (5X20T)

ITALWEBER - UL 248-14
T 16 A - Serie HT (6,3x32T)

ITALWEBER - UL 248-14
T 16 A - Serie HT (6,3x32T)

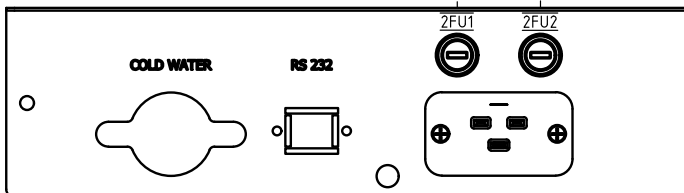



Authorized Tuttnauer Distributor Since 1992

39 Western Highway, West Nyack, NY 10994

877-561-0500

sales@duralinesystems.com | www.duralinesystems.com